

Live the way you are – naturally individual:
UNILUX aluminum clad wood windows



ALUMINUM CLAD WOOD WINDOW OVERVIEW



WHERE QUALITY IS AT HOME

Live the way you are – naturally individual: UNILUX aluminum clad wood windows



WHERE QUALITY IS AT HOME

Contents

UNILUX: Where quality is at home	4-5
All good things come in sixes: Brand advantages of UNILUX	6-7
Advantages of aluminum clad wood	8-9
UNILUX aluminum clad wood windows Discover diversity	10
UNILUX aluminum clad wood windows Passive house stars	11
UNILUX aluminum clad wood windows series DesignLine Privacy	12-13
UNILUX aluminum clad wood windows frames for renovation	14-15
Quality as a standard: the basic UNILUX advantages	16
Extra perfect: the UNILUX optional advantages	17
Freedom of design in terms of material and color	18-19
Glass competence	20
Added security	21
Unlimited variety of shapes, handles, shades and screens	22-23
The unique UNILUX MAXXIGLASS gallery	24-35
References	36-37
The reliability of a big name	38-39

Live the way you are – naturally individual: UNILUX aluminum clad wood windows



WHERE QUALITY IS AT HOME

UNILUX

One brand. One promise.

The only thing modern-day windows have in common with their "ancestors" is their name. Good carpentry work and appearance alone is no longer enough, because energy efficiency, safety, and functionality standards have increased dramatically to meet today's customer needs.

That's why all UNILUX aluminum clad wood products are inhouse developments, demonstrating an extraordinary degree of product intelligence and complex engineering.

To ensure these masterpieces are not just available to a selected group of people, UNILUX produces them as series, enabling these unique aluminum clad wood products to be sold at prices which make top quality affordable.

UNILUX – where quality is at home



All good things come in sixes:

The UNILUX brand advantages

Brand advantage 1: Durability

Ever since its early days, UNILUX has always used the highest-quality materials. Down to the finest detail: instead of the inferior silicon, we use smooth glazing seals made from synthetic rubber. The high-quality workmanship and strict quality controls ensure you gain long-term enjoyment from your UNILUX window.

Brand advantage 2: Freedom of design

Some things are a matter of taste. Thus, you can choose from our three designs – LivingLine, ModernLine and DesignLine. And that's just the beginning. Every one of those models can be customized. From the choice of wood to the coloring – all RAL colors for aluminum and special wood colors up to the handles. And let's not forget: a wide variety of window shapes (they don't have to be rectangular, after all) and muntins upon request in four different lines. Variety right from the factory.

Brand advantage 3: Energy efficiency

UNILUX's solid construction style not only guarantees durability, but also helps save energy. In the standard version, each of our wood-aluminum windows has a „warm edge“ which forms the thermal separation between the glass panes. That provides better insulation values, more comfort in the vicinity of the window, and significantly less condensation in cold months. Heating costs can be further reduced in conjunction with a highly efficient triple-glazing.

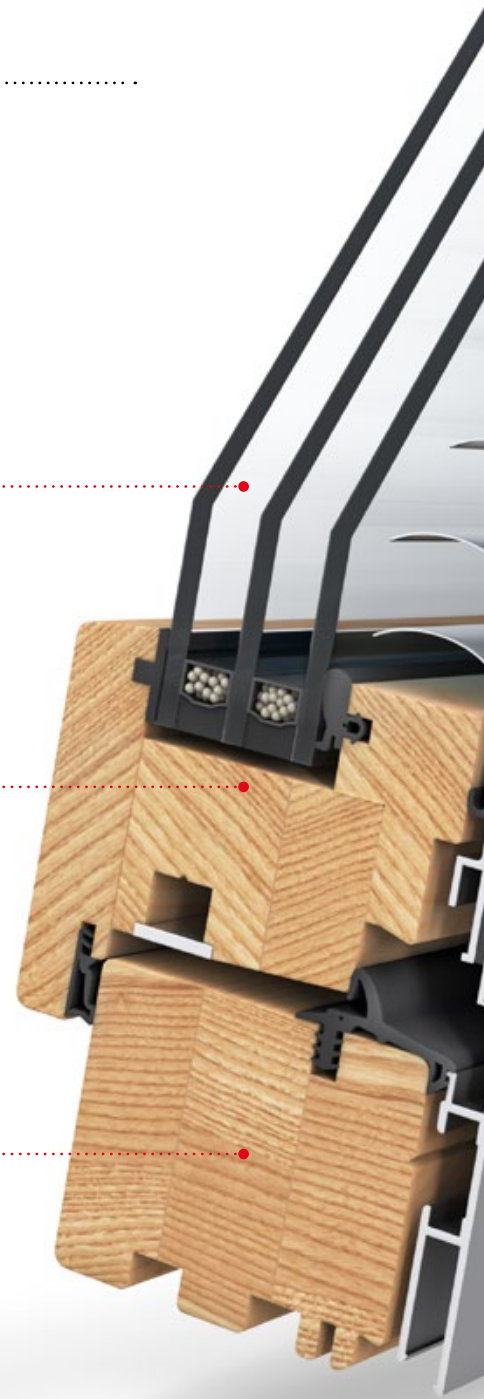

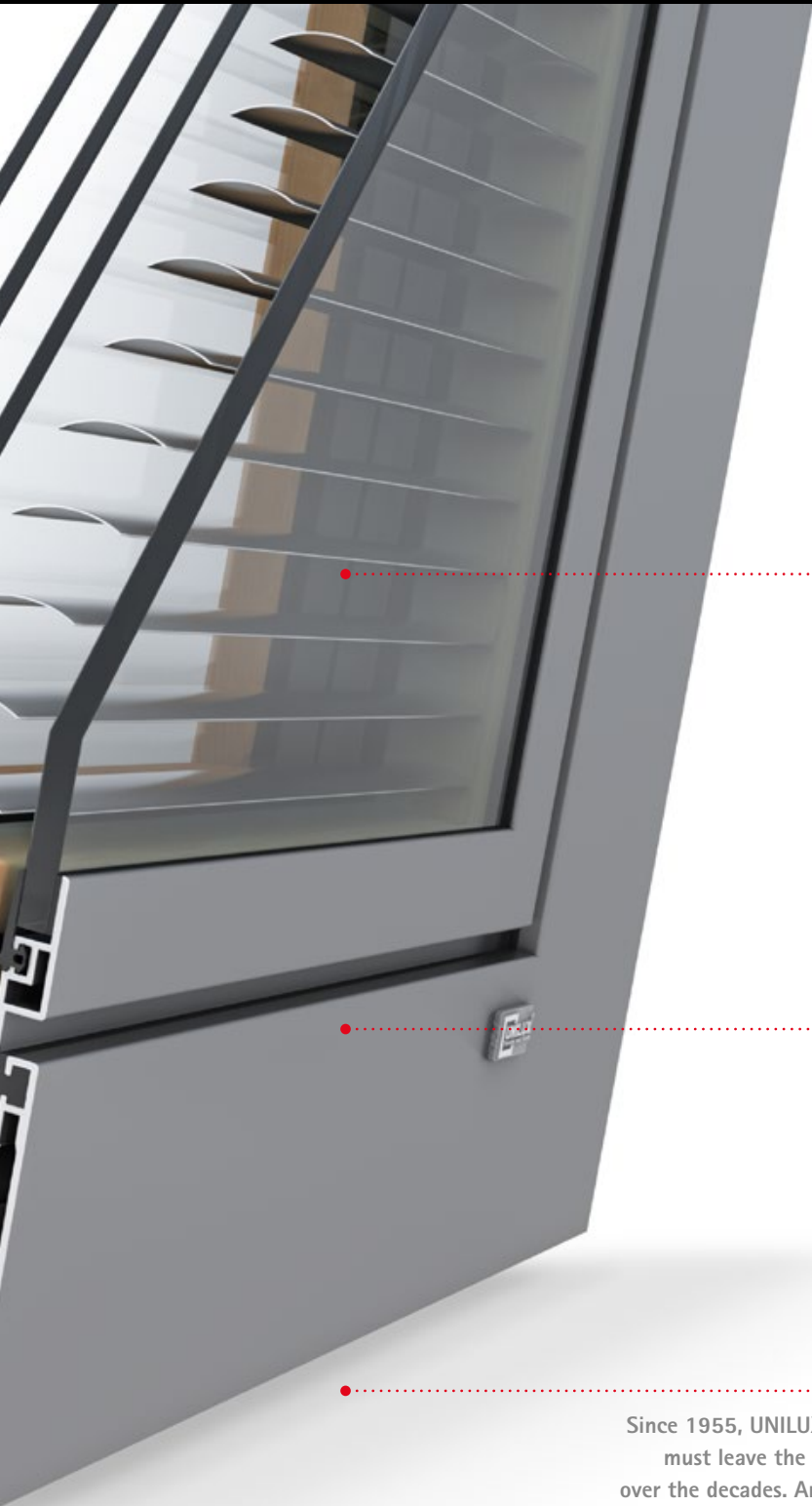

Brand advantage 4: Safety

Sometimes a window's job is not just to keep out wind and rain, but also uninvited guests. That's why all UNILUX locking parts are made from high-quality materials. Mushroom pins are also a standard feature of all our aluminum clad wood window fittings. For those who want even more security, we offer maximum protection with our SAFE packages. Read more on page 21.

Brand advantage 5: Service

UNILUX only works with expertly qualified window specialist retailers, located across the country with their own showrooms. Your regional UNILUX retailer will offer you detailed advice and assist you with your plans. It will also ensure prompt, correct installation, and will be available at any time if you have any service-related needs.

Brand advantage 6: Brand quality

Since 1955, UNILUX's philosophy has been: Only products of uncompromising quality must leave the factory. This saw our company become a recognized quality leader over the decades. Anyone who pays heed to the UNILUX logo can be certain of always receiving a "Made in Germany"-branded product.

Live the way you are – naturally individual: UNILUX aluminum clad wood windows

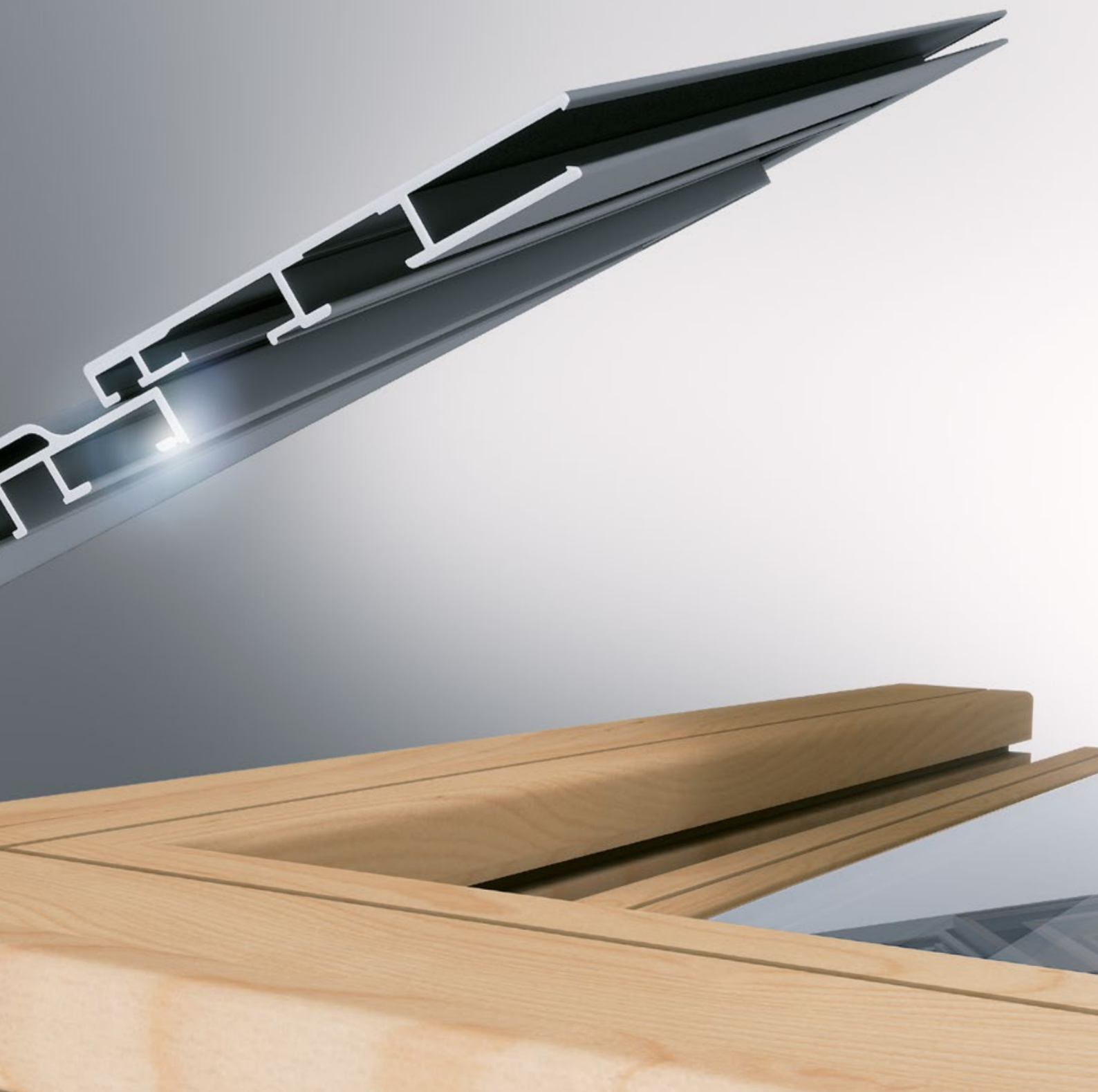

WHERE QUALITY IS AT HOME

ADVANTAGES OF ALUMINUM CLAD WOOD

Aluminum on the outside,
pure wood on the inside –
combined for generations.

Wood creates comfort – it is a feel-good material. Aluminum on the other hand, is a robust protective shield against the elements. Together, they form an aluminum clad wood product which lasts generations without the need for continuous maintenance.

The wood interior does not require UV protection in the form of coloring pigments in the finish. It can be used in its natural form (transparent stain) thanks to the aluminum shell. The aluminum shield firmly encases the wood, protecting it from the elements while still giving room to expand and contract and cope perfectly with temperature fluctuations.

UNILUX aluminum clad wood products: THE ORIGINALS.



Aluminum Clad wood windows

Discover diversity

No house is like any other. To help you design your window to your own taste, we offer you three different designs.

In the standard version UNILUX wood-aluminum windows can achieve a U_w -value of up to 0.83.

U_w -VALUE
0.83
W/m²K



Unilux DesignLine

The attractive way to save on energy costs (heating or cooling). The DesignLine aluminum clad wood window range combines architectural elegance and state-of-the-art energy efficiency. Uncompromising in terms of aesthetics, it is designed for high-quality residential buildings and condominium buildings.

Unilux ModernLine

Three glass panes with a thickness of nearly 5mm (2"), a custom-designed insulating core, thermally isolated spacers, special filling gas, and invisible coating on both sides improve insulation values by 46% compared to conventional windows.

Unilux LivingLine

Some things never need to change. The aluminum clad windows in the LivingLine series are so discreet that they fit harmoniously into any traditional architecture, and are very attractive when renovating older buildings as well.



WHERE QUALITY IS AT HOME

PASSIVE HOUSE STARS

The Passive House stands for healthy and comfortable living with high energy efficiency.

As a premium manufacturer of wood-aluminum windows, UNILUX has adapted the development of its product range to meet these requirements, because our wood-aluminum windows allow you to achieve passive house standards.

The core for more insulation

U_w -VALUE
0.73
W/m²K

An additional insulating core in the window frame helps to achieve a better thermal insulation. In addition, the pine wood naturally provides a good insulation value. In this combination, the wood-aluminum windows can reach a U_w -value of 0.73. Thus, they can meet the strict criteria for passive house windows. This means that you automatically have to heat less.



Aluminum clad wood windows

DesignLine Privacy

“My home is my castle.” Just block the world out. Be undisturbed, footloose and fancy free. This is easy with the aluminum clad wood DesignLine Privacy window. Thanks to integrated blinds, you can create privacy at any time – even by remote control if you wish. Also save on energy compared to a roller-shutter or venetian blind box.



DesignLine Privacy Advantages on 4 levels

1. Privacy

Discretion could not be more easily achieved. Nothing has to be built, mounted or improvised. The blinds move easily, via remote control if required.

3. Warmth

Roller-shutter or venetian-blind boxes are often energy guzzlers. Heat escapes and cold creeps in. DesignLine Privacy gets rid of this airlock. Since the blind is now part of the window, the boxes are no longer required.

2. Peace and quiet

Three or even four glass panes mounted some distance from one another enable unrivalled sound-proofing. Test it for yourself and pull the blind up: You'll see the cars but won't hear them.

4. Freedom of design

The integrated blind – with your choice of color – offers you a wide range of possibilities. As you don't require shutters, curtains or separately mounted blinds, your freedom of design is greater than ever before.





Try out more comfort.

As an option to the standard chain cord, the blinds integrated into many windows* can now be operated by remote control from the comfort of your sofa, armchair or bed.



UNILUX DesignLine Privacy



Internal blind

The energy-efficient alternative to the box above the window. It can be easily adjusted to the sun's position via motor or chain. As it is located inside, it hardly gets dirty, either.

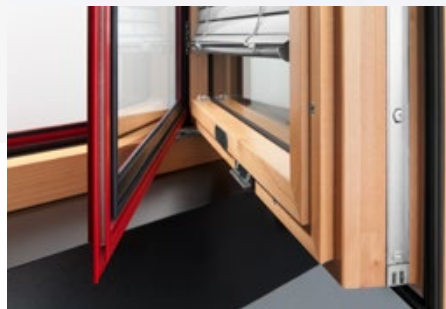

Easy to clean

The blind sits in front of the insulated glass unit, making the rare cleaning sessions a piece of cake. Simply open the sash, clean it, and you're done!

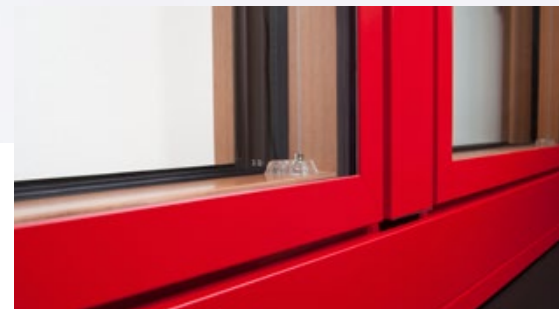

Sleek appearance

No frills, no gadgets. The DesignLine models stand for clear, puristic lines. Timeless window design.

* Depending on the size of the window.



Aluminum clad wood windows frames for renovation

The smart way to renovate windows

Window renovation can be so easy! Thanks to the renovation window frame from UNILUX, replacing obsolete windows is child's play. You don't even need to worry about plaster or wallpaper. Everything gets done cleanly and quickly.

Experienced installers manage that by simply removing the sashes of your old windows and cutting off the frame. Then they already have the groundwork laid for your new wood-aluminum window.

You can choose from all the many variants of a DesignLine window. And just like windows for new construction, you have all the different options for design available. For custom windows at lightning speed.

The decisive factor: The skill of installers matches the high quality of our windows. So you can be absolutely certain that your energy-saving DesignLine window with renovation window frames will have the same thermal insulation values as a DesignLine window in a new house. And plastering and wallpapering? They're just as much a thing of the past as masonry repair.

The renovation window frame from UNILUX – new windows, without the stress.



New windows, no muss, no fuss.

Clean insertion into the old window frame leaves the masonry and stucco intact, and interior plaster and wallpaper aren't affected either. Even an existing window sill can be cleanly integrated.

The new window fits harmoniously into the existing window opening, from both the visual and technical points of view.

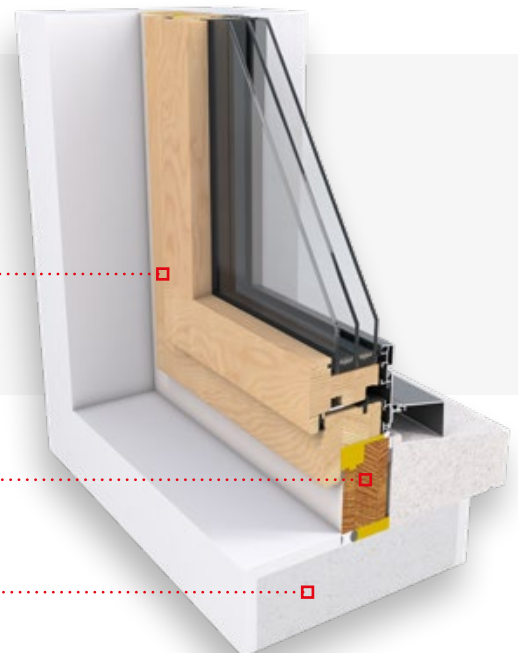

New renovation window frame

Old window frame

Masonry and stucco

U_w-VALUE

0.8

W/m²K



UNILUX
renovation window frames

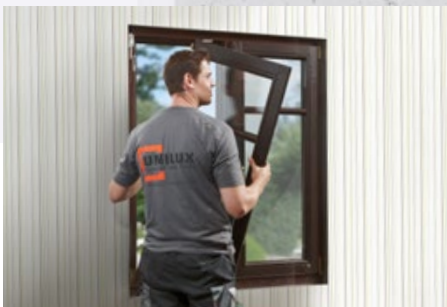

Clean

The entire area is cleanly covered and taped before work begins. The old window sashes are removed, and the old frames cut off without leaving dust. They will be used as the foundation of the new window structure.

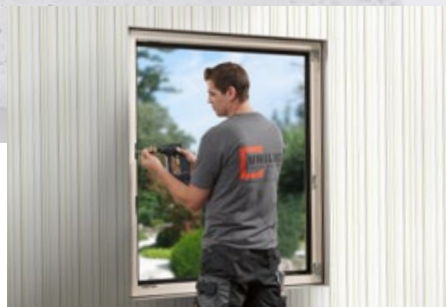

Safe

By stable anchoring into the frame and the masonry and by adding foam and insulation, our new windows aren't just visually attractive – they're also attractive when it comes to security and thermal insulation.



Fast

Once the new frame is inserted and anchored, the only thing left to do is simply to mount the new sashes. And then your room shines in a new light – without the mess, and without the stress.

Quality as a standard: the basic UNILUX advantages

As you know from buying cars, some models look cheap at first glance. But upon closer examination, you are incredulous at all the extras charged by the manufacturer.

That's not the case at UNILUX. Our basic features in themselves are so extensive, that there is often no need for accessories. Each of our standard aluminum clad wood windows has the following special features:

Glazing seal



Silicon may be cheap, but it fades easily, is hard to clean, and susceptible to cracks and abrasion. UNILUX uses the better alternative: synthetic rubber, which is easy to clean, fade-resistant, long-lasting and hardly noticeable.

Aluminum cladding slider couplings



Aluminum contracts or expands more than wood in cold or hot weather, creating tension on the frame. We prevent this from happening by mounting the aluminum cladding on slider couplings – similar to a rail system. This also ensures the wood is properly ventilated at all times.

Superior-quality wood

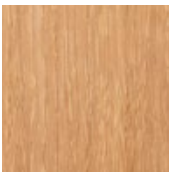

Not all woods are the same. To guarantee a consistently high quality of materials, we use our own experienced wood purchasers, even in the most distant of supply countries. The same strict standards are applied during treatment – to ensure the wood has a long and healthy life.

Embedded lock keepers



Impressive not only aesthetically, but also from a security perspective – due to being recessed compared to screwed-on locking parts. And the window frames are also easy to clean due to the fact that all the metal parts are recessed/embedded.

Aluminum powder coating

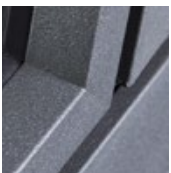

"The exterior paint has chipped" is a phrase unfamiliar to UNILUX customers. Because our aluminum clad wood windows are made using aluminum powder coating, which has been tried and tested in the automotive industry. The result is highly robust paintwork able to withstand even the harshest of elements.

Extra warmth: Triple glazing



Three panes are part of the standard fitting for UNILUX. This ensures improved thermal insulation and thus lower energy costs. Since the pane can have a thickness of 32 to 52 mm, it can also be efficiently equipped with noise protection.



Extra perfect: the UNILUX optional advantages

Special circumstances require special solutions. That's why UNILUX offers exclusive added value when it comes to security, material protection and energy usage.

These additional benefits also give you the peace of mind of knowing you have the ultimate aluminum clad wood windows. Perfection, made by UNILUX.

Added security: SAFE



In standard version, our windows and glazed doors already have secure mushroom-pin locks. For those who want even more security, we offer maximum protection with our SAFE packages. Choose between SAFE +, SAFE ++ and SAFE +++.

Plus: Aneloxal coating



It's not just acid rain which can corrode metal. Salty sea air can also have aggressive, negative impacts up to 60 miles/100 kilometers inland – including on stainless steel. Pre-anodising, – the "aneloxal" process – effectively prevents corrosion. We are one of the very few manufacturers to use this form of coating at customers' requests, thereby ensuring UNILUX aluminum clad wood windows remain a symbol of durability, even in coastal areas.

Glass competence



You can not only design UNILUX windows visually, our glass can also be completely customized to your needs. It's your choice: Noise protection, security, sun protection or a higher degree of thermal insulation – with UNILUX nothing is left to be desired.

Wood-aluminum 0.7 advanced



Wood-aluminum windows from UNILUX already have a good thermal insulation value in their standard version. For all those who want a special insulation, we build an additional insulating core in the window frame. This makes your window passive house compatible.



Freedom of design in terms of material and color

How many different tastes are there? Around 2 million when it comes to wood and color. Because that's how many combination options you have for your individual UNILUX aluminum clad wood windows. Find out which wood species goes best with which color, and which pattern goes with the aluminum cladding.



Eukalyptus Grandis



Larch



Pine

For interior design (= the wood variety and wood coating) there are 4 wood varieties and 200 colors available (covering RAL colors and wood glaze tones). You have even more options for the exterior design (= the aluminum covering). Here, you can choose from over 2,100 colors or decors (RAL, NCS, DB/Eloxal and white pigment colors as well as wood decors).

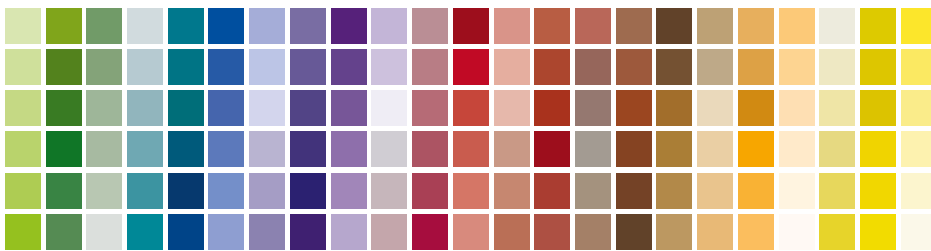

RAL colors
Wood patterns
DB & metallic colors
NCS colors



Colors may vary due to printing.



Choose from the following wood species: Pine, Oak, Larch and Eukalyptus Grandis, as well as 20 transparent or semi-transparent finishes.

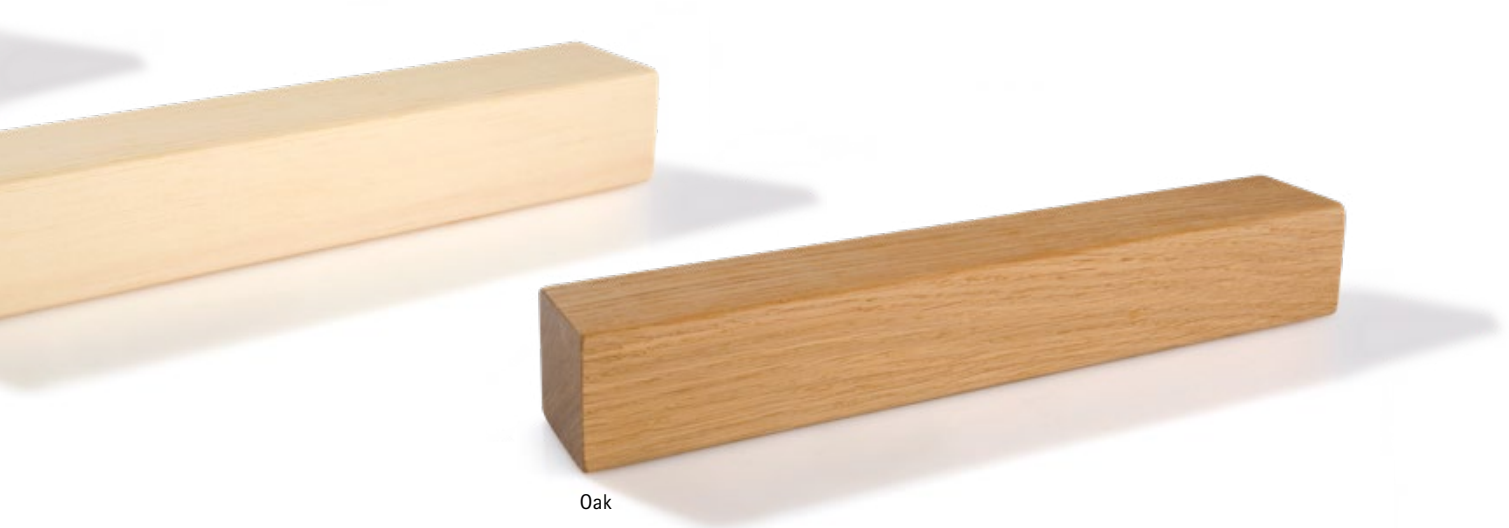

Oak



You love wood

Wood is a living material, so it's nice if you can incorporate it into your living space. UNILUX aluminum clad wood windows bring this vitality to your living room.



Your world is colorful

Colors are an expression of personality and attitude towards life. Show off your taste and choose from a range of colors which leaves nothing to be desired.



It's your choice

Even when it comes to wood colors, UNILUX always gives you the choice. Select from a wide variety of wood species, and make the most of the options for designing the wood's color scheme.

Glass competence

UNILUX sets high standards in terms of glass, that is why every UNILUX window is fitted with 3-pane insulating glass as standard. But that alone is not enough for our engineers and developers. For all those who want more than just to design their windows, UNILUX offers various possibilities to upgrade their glass. However you decide, every UNILUX window is an example of groundbreaking glass competence.

Thermal insulation



These standard UNILUX glasses achieve insulation values that are by no means commonplace for windows. If that's not enough, you have the option to upgrade. You have the choice between

MegaTherm, which achieves sensational insulation values thanks to argon/krypton gas filling. Or PrimaTherm 0.6 White - Thanks to a new, invisible Low-e coating, you can use the energy from the sun's rays more effectively. More solar heat finds its way into the house. At the same time, this coating ensures that the cold stays outside.

Safety glass VSG, P2A + P4A



At UNILUX you get the glass that is adapted to your security needs. Starting with ball-proof safety, which is nowadays in demand not only in sports halls but also increasingly in private homes, up to

the P4A glass, which withstands rough attacks, such as stone throwing or hammer blows. The tested safety glass is joined with an invisible high-tear-resistant film between two panes and ensures adhesion and tension in case the glass shatters. The security class can be further enhanced by increasing the number of plastic films and glass panes.

Sun protection



Large window fronts bring brightness and atmosphere to our buildings. On the other hand, rooms can heat up quickly as the sun shines on the generous window panes. To counteract this, UNILUX

offers you sun protection glasses. The sun protection glass has two functions: In summer, it reduces solar radiation and thus reduces the heating of the building. In cool weather, the glass acts as a thermal protection and saves energy. The rays of the sun are reflected or absorbed by the solar protection glass without darkening the room.

Noise protection

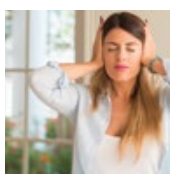

One of the important tasks of a home is to ensure sleep and recuperation. Regrettably, the noise pollution of our environment has greatly increased in the past. UNILUX offers the suitable glass for different

noise sources - whether for buildings on busy roads or near discos and airports. UNILUX offers you high-quality glazing with improved sound insulation up to class 5, i.e. up to 45 dB (test value).



Added security

Protect your most valuable items. Burglars are risk-conscious people. They are quickly dissuaded once they realize the hurdles are too high. Thanks to sturdy profiles, anti-burglary fittings, lockable handles and special safety glass, UNILUX ensures that thieves think twice before attempting a burglary. Our windows and patio doors help to ward off suspicious characters.

The wood-aluminum windows from UNILUX already feature a mushroom pin in the standard version. With the SAFE packages you additionally reinforce the resistance of your windows against burglaries in three stages (+, ++ and +++). Thus you are always on the safe side with your windows.

STANDARD

Standard lock

Locking window handle

SAFE+

4-corner security lock
(Mushroom pin + safety striker plate)

Window handle with locking button

SAFE++

4-corner security lock
(Mushroom pin + safety striker plate)

Window handle lockable

Drilling protection on gears

SAFE+++

Security lock all around
(hardware suitable for elements of class RC2)

Window handle lockable

Drilling protection on gears

Of course for the highest security requirements we also offer the DIN EN-tested safety classes RC2 and RC2N. In this configuration, the UNILUX windows were tested intensively for you by neutral testing institutes.

RC2

Security lock all around
(hardware suitable for elements of class RC2)

Window handle lockable

Drilling protection on gears

P4A glazing

Tested according to DIN EN 1627-1630:2011

Tested glass connection
(gluing the pane)

RC2 N

Security lock all around
(hardware suitable for elements of class RC2)

Window handle lockable

Drilling protection on gears

Any desired glass

Tested according to DIN EN 1627-1630:2011

Tested glass connection
(gluing the pane)

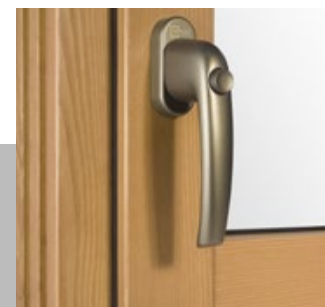



Endless variety of shapes

There are practically no limits when selecting the shape of your aluminum clad wood windows. Triangular or circular window? Sectional or semicircular arch? With or without SDL or TDL bars? Your specialized UNILUX trade partner will show you what's possible.



A handle on design

Design you can grab: Every UNILUX handle is not only a solid piece of "Made in Germany" workmanship, but also a visual gem. A tool enabling you to express your taste and style.



Standard handle
silver colors

Standard handle
steel colors

Standard handle
bronze colors

Standard handle
white

Stainless steel handle
angular shape

Stainless steel handle
L-shape

Stainless steel handle
U-shape

Shades and screens

There are different options for protection from intensive sunlight and curious eyes. Whether classical roller shutter, elegant Venetian blinds, or traditional aluminum shutters, UNILUX offers you your individual shade and screen solution. By the way, we have a few good recipes against insects, too.



Venetian blinds

Blindingly bright or pitch dark? Venetian blinds give you many more nuances than that. They can control incoming light on a continuous basis. The strips, with their adjustable tilt, allow you to determine exactly how much sunlight you let into your rooms. And the Venetian blind also has an excellent visual appearance.

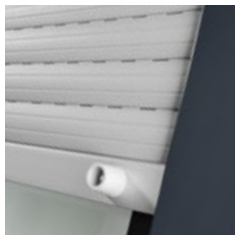

Roller shutter

When it comes to blocking out light, roller shutters have been the benchmark forever. No wonder they're preferred for use in bedrooms. And since the box appearance is the same as for our venetian blinds, you can combine UNILUX roller shutters and Venetian blinds together harmoniously.

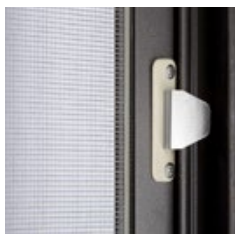

Insect protection

It's not just in bedrooms that insects are a bother. Biting flies and wasps can rob your enjoyment of the fresh air. So you can still air out without the worries, there are special clamping frames and rotating doors. You can easily mount these insect screens yourself. Comfort is so easy.

Every house facade is different. That's why UNILUX lets you select from different box variants when it comes to privacy protection.

For new construction we recommend plaster base variants, because roller shutters or Venetian blinds are then integrated into the external stucco. There is no break in the masonry in this case – no thermal bridge, meaning less energy consumption.

Good to know: For boxes with exterior serviceaccess, you can put up wallpaper inside with no worries – the visually bothersome access-cover disappears.



Round roller shutter

Round visuals, specifically eye-catching.



Plaster variants

Behind the stucco – nearly invisible.



Variety of bars and dividers

Divided lights are the icing on the cake when it comes to a window's appearance. Our range covers four different lines, from true divided and simulated divided lites to the astragal and georgian bar designs.

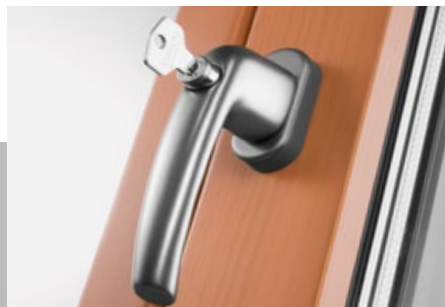

Lockability

Not every window needs to be opened, especially when there are small children around. That's why most of our handles come with a lock button, and are also available as lockable variants. Just in case.

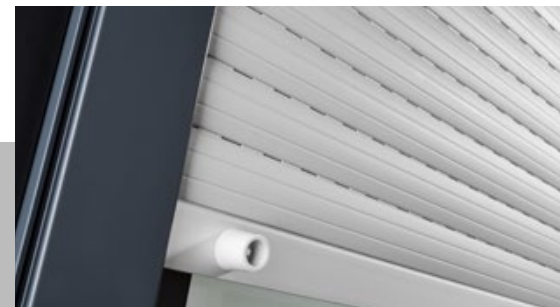

Sunshades and more

At UNILUX, we have first-class roller shutters, and insect screens that are either built into the roller shutter box or act as a separate component.

The unique UNILUX

MAXXi

GALLERY

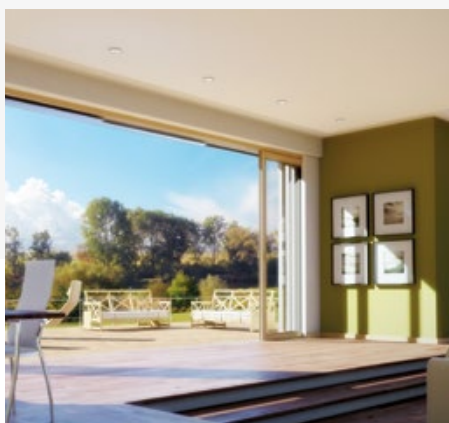

GLASS

For unlimited vision and new spheres of experience.



Full-glass corner window

OpenView

The dream which comes true.

OpenView allows you to gaze far into the distance – without any interfering window frames in the corner. Uninterrupted views for as far as the eye can see.

Technical masterpiece

While completely transparent, it conceals a sophisticated UNILUX construction. During the assembly of the assembly glass an insulation is integrated which is not visible to the naked eye. The black stripe that characterizes the glass corner consists of high-quality enamel, which is optically refracted in the glass so that only a shadow gap is visible. Typically UNILUX - masterfully crafted down to the last detail.

Freedom of design

Whether as a strip of tall windows or a large glass field, OpenView adds value to modern, high-quality architecture. Of course, this impressive structural feature comes in wood species, contours, wood colors and external colors which blend in perfectly with the UNILUX aluminum clad wood windows. It is also available with energy saving triple-pane glass, upon request.



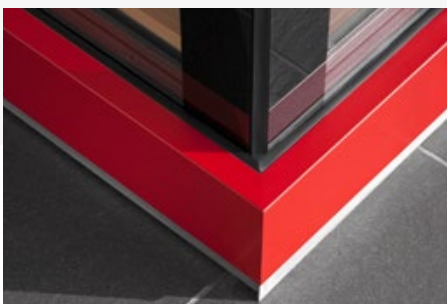

Maximum performance

Namely, in terms of energy and architecture: The corner is joined via an assembly glass. This allows for an almost invisible insulation of the glass behind it.

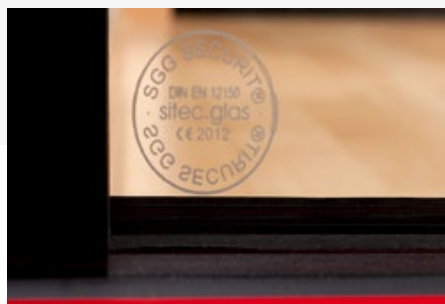

Safety glass

The standard tempered safety glass (with seal) ensures firmness and optimized load distribution.

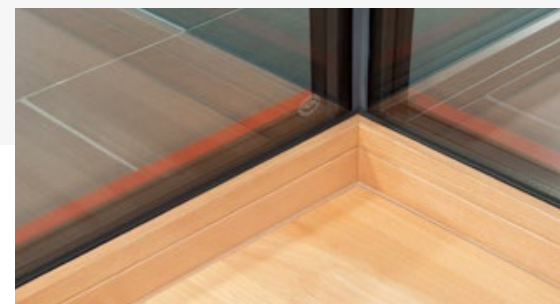

Slender profile

The filigree design enables maximum transparency. Aesthetics and robustness become one thanks to the safety glass.

Lift/Slide system

HS

The classic model in its most convenient form. With the lift/slide system, you'll see how sliding becomes gliding. A simple panel movement creates an opening approximately 10'3 meter wide and 9'2.8 meter high.

Exemplary craftsmanship

The lift/slide system perfectly demonstrates nature of UNILUX's products. High-quality hardware and solid constructions enable long-lasting elements which ensure maximum views and grand openings.

Freedom of design

Easy on the eye: The lift -slide system comes in wood species, contours, wood colors and external colors which blend seamlessly into the UNILUX aluminum clad wood windows.



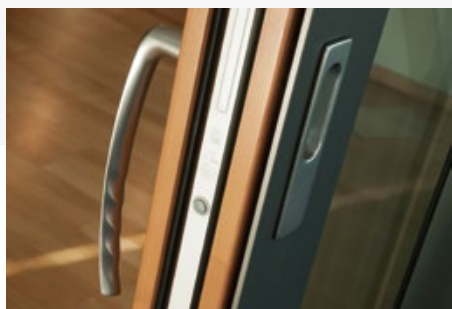

A handle on everything

Thanks to a practical recess and solid handle, the panels can be easily moved both inside and outside. The system also comes in a lockable version.

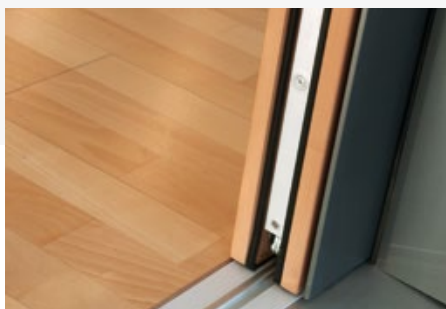

Low threshold

No stumbling, no stopping. Inside and outdoors join seamlessly. Freedom from barriers that's also visually attractive.



Shared sash profiles

Design from the same mould: The sash profiles of the lift/slide system are tailored to the entire UNILUX line.

Bi-Fold (sliding-folding) system

Exterior

There are no obstacles here. You don't need to move any plants or standard lamps, because the door panels fold outwards, creating an opening up to 25/7.7 meter wide and 9'/2.8 meter high. And a nice benefit: If you open the door after a rain shower, the water automatically drains to the outside – leaving everything dry inside.

Exemplary durability

The bi-fold door perfectly demonstrates the stable and durable nature of UNILUX's products. Aluminum is used as the base material and wood as the cladding, creating a high degree of rigidity in one element, in which everything fits perfectly together.

Freedom of design

Easy on the eye: The bi-fold door comes in wood species, contours, wood colors and external colors which blend seamlessly into the UNILUX aluminum clad wood window line (including energy saving triple-pane glass). Even the external handle can be matched to the unit's exterior color. And upon request, the bi-fold door is also available with embedded threshold.





Seamless connection

Depending on the architecture, the panels' castors can be integrated into the floor – forming the basis for a flat sill track and fluid transition.



Freedom of interior design

As the panels open outwards, you don't need to create any space for them inside. And when they are opened, raindrops land on the terrace instead of the floor.

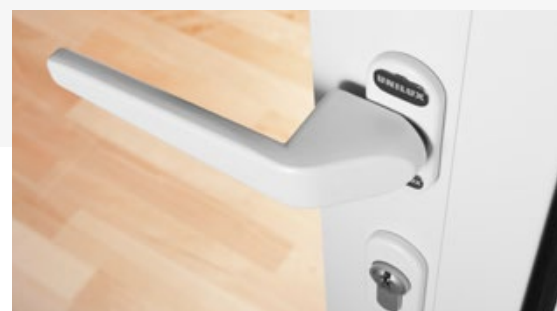

Handles

Practical when you want to get out quickly. Depending on how the elements are divided, a standard door handle can be installed (in the same color as the element's exterior).

Facade system (Curtain Wall)

FineLine

The name's the game. FineLine is distinguished by its slender yet solid post & beam construction. The sophisticated connection technology allows even tricky architectural tasks to be mastered with maximum quality.

Exemplary strength

UNILUX only uses solid, laminated wood protected by a weather-proof aluminum cladding, which also holds the glass panes in place. These robust materials, as well as the sophisticated, invisible connection technology for posts and beams, ensure maximum stability even for large façades extending beyond one floor.

Freedom of design

Easy on the eye: The large glass areas enable personalized interior design. The slender, elegant FineLine façade comes in a variety of wood species and colors, contours and aluminum exterior colors, which blend seamlessly into the UNILUX aluminum clad wood window lines. Available with energy saving triple-pane glass, upon request.



WHERE QUALITY IS AT HOME



Bildnachweis: 2



Energy efficiency

Optimum U-value according to passive house standards is achieved, thanks to the thermally insulated construction. The heat stays in and the cold stays out.

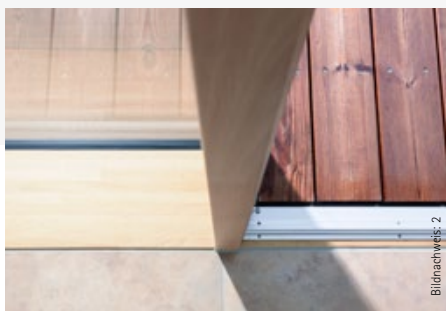

Bildnachweis: 2

Aesthetics

Solid wood, perfectly presented. The base connection with post-and-beam profile is just one example of the importance UNILUX places on high-quality architectural solutions.

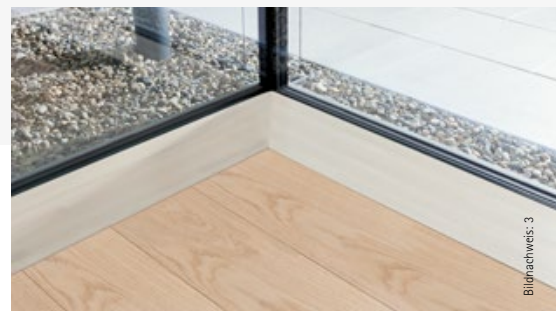

Bildnachweis: 3

Workmanship

Closer inspection please. Examining details reveals just how much precision work goes into each UNILUX product.

Large-scale door

JumboLine

High window elements are increasingly popular. It's good when balcony doors can keep up. While the standard balcony door gives out after 2.60 meters (8'-6"), our JumboLine balcony doors can manage heights of up to 3 meters (10'). The key are the massive PowerHinge hinges, which can manage loads of up to 300 kilograms.

Harmony in completion

Engineering and aesthetics make a harmonious couple. For example, the sash limiter which prevents the panel from excessive opening is only visible when the door opens. The structural glass and securely anchored hardware ensure maximum stability – the panel is easy to operate even after many years.

Seamless integration

The JumboLine is available in all the aluminum clad designs, aluminum colors, wood species and finishes of the standard aluminum clad wood windows.





Strong hardware

Thanks to solid door hinges, even heavy panels (as a standard up to 385 lbs/175 kg, with PowerHinge up to 660 lbs/300 kg) are a piece of cake for this large door. And a durable construction ensures long-lasting use.



Invisible sash limiter

To protect the hinges, standard JumboLines have a build-in, invisible turn restrictor which automatically stops the door from opening beyond a 90° angle.

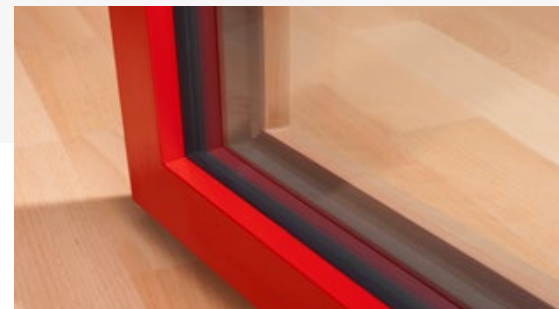

Filigree profiles

The door may be tall and heavy, but its panels are just as slim as any of our elegant tilt-and-turn windows.

Live the way you are – naturally individual: UNILUX aluminum clad wood windows

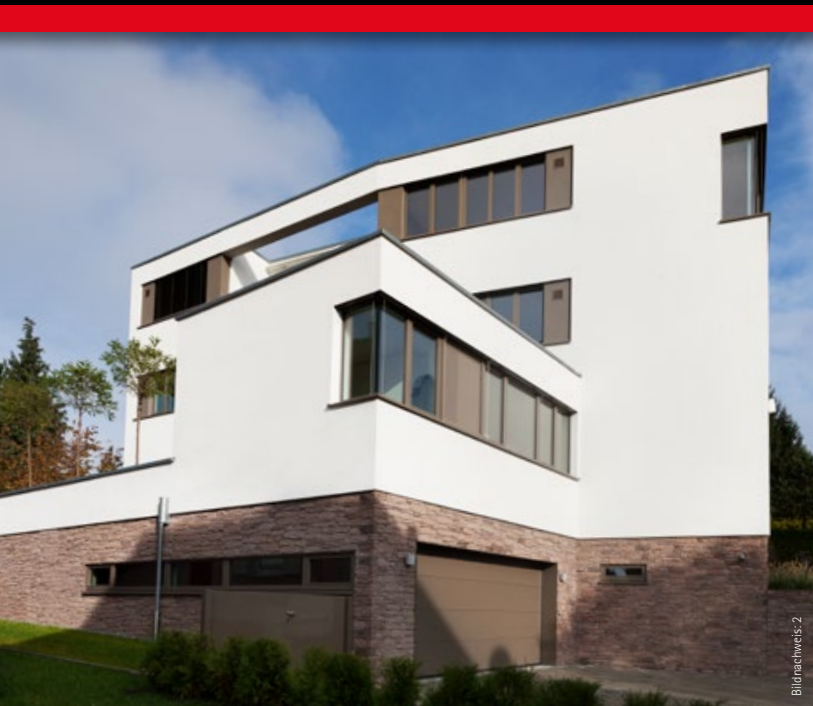



Bildnachweis: 6



Bildnachweis: 7



Bildnachweis: 1



Bildnachweis: 6

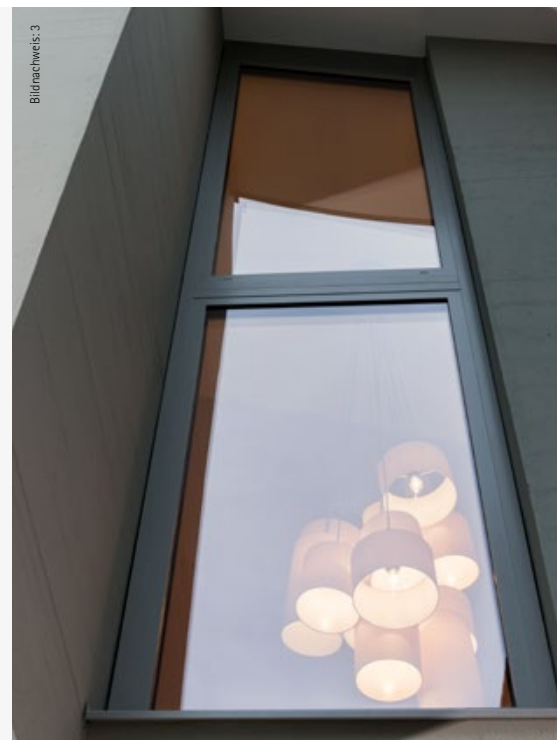

Bildnachweis: 3



Bildnachweis: 6



Bildnachweis: 1



Bildnachweis: 6

The reliability of a big name

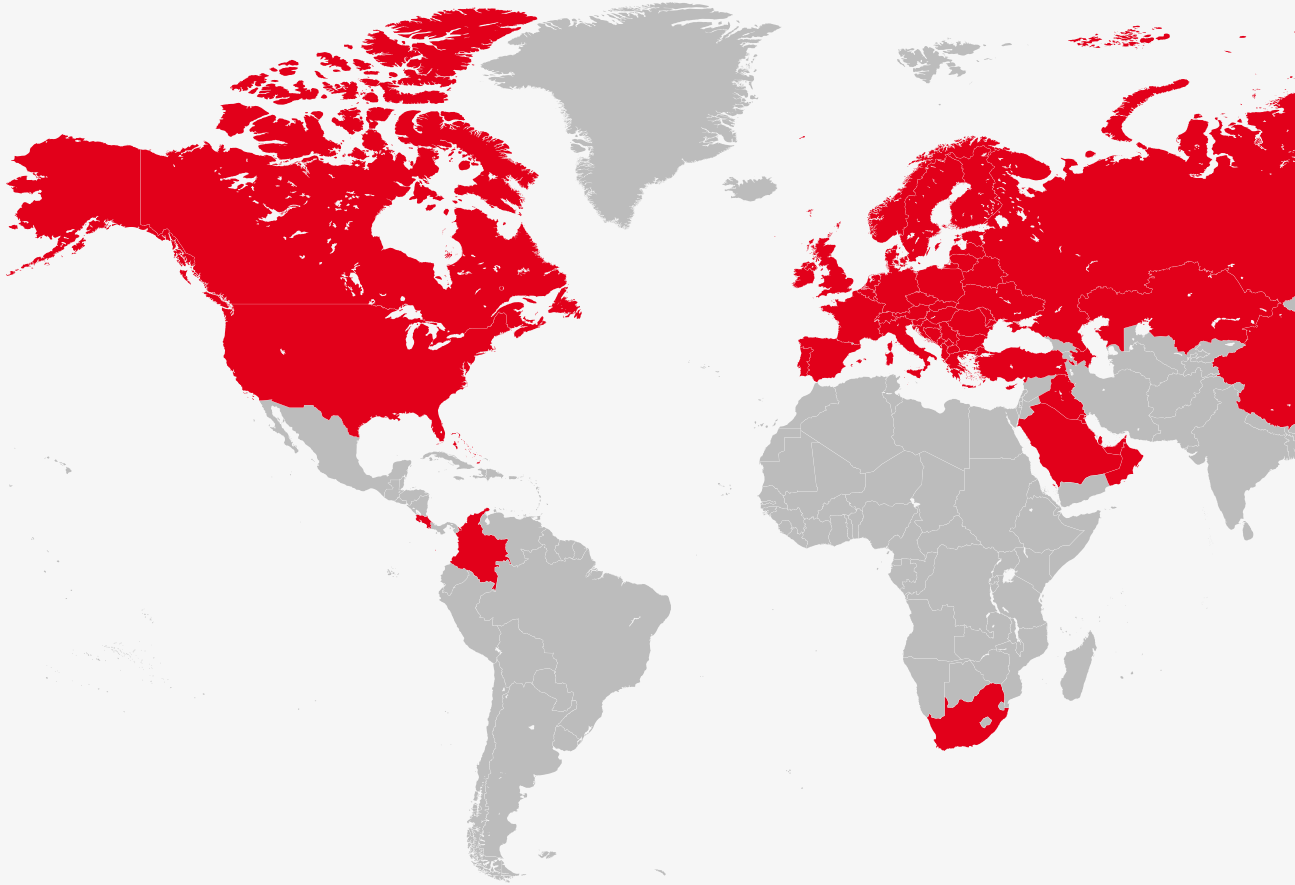

UNILUX ensures award-winning long-term progress

- by selecting the right partners and raw-material suppliers, and by being a member of leading institutions and associations:



UNILUX products meet international test and safety standards:





Company info

Publisher

UNILUX GmbH
54528 Salmtal / Germany
Telephone +49(0)6578/189-0
Facsimile +49(0)6578/1880

E-Mail info@unilux.de
www.unilux.de

Notes

The content of this catalogue is not legally binding and may be subject to technical changes as part of further developments or errors in the text, images or descriptions. We only allow images and text material – including excerpts – to be used upon request, and with our express written consent.

The image material used is for illustrative purposes. Differences in color are unfortunately unavoidable due to printing. The sample illustrations are not to scale.

© 2019, UNILUX GmbH. All rights reserved.



UNILUX headquarters, Salmtal

UNILUX GmbH
54528 Salmtal / Germany
Telephone +49 (0) 65 78 / 189 - 0
Facsimile +49 (0) 65 78 / 18 80
E-Mail info@unilux.de

www.unilux.de



WHERE QUALITY IS AT HOME

Member of the **WERU** Group