

Live the way you are – naturally individual:
UNILUX uPVC windows



UPVC WINDOW OVERVIEW



WHERE QUALITY IS AT HOME

Live the way you are – naturally individual:
UNILUX uPVC windows



Contents

UNILUX: Where quality is at home	4-5
All good things come in sixes: Brand advantages of UNILUX	6-7
Advantages of uPVC	8-9
UNILUX IsoStar	10-11
UNILUX IsoStar-Alu	12-13
UNILUX IsoPlus	14-15
UNILUX IsoStar HS	16-17
UNILUX IsoStar-Alu HS	18-19
UNILUX IsoPlus HS	20-21
UNILUX IsoPlus HS LUX	22-23
uPVC window options	24-29
The reliability of a proven name	30-31

Live the way you are – naturally individual:
UNILUX uPVC windows



WHERE QUALITY IS AT HOME

UNILUX

One brand. One promise.

The only thing modern-day windows have in common with their "ancestors" is their name. Good carpentry alone is no longer enough, because energy efficiency, safety, and functionality standards have increased dramatically to meet today's customer needs.

That's why all UNILUX uPVC products are developments, demonstrating an extraordinary degree of product intelligence and complex engineering.

To ensure these masterpieces are not just available to a selected group of people, UNILUX produces them as series, enabling the unique products to be sold at a price which makes top quality affordable.

UNILUX – where quality is at home.



All good things come in sixes:

The UNILUX brand advantages

Brand advantage 1: Durability

Ever since its early days, UNILUX has always used the highest-quality materials. Down to the finest detail: we use smooth glazing seals made from synthetic rubber. The high-quality workmanship and strict quality controls ensure you gain long-term enjoyment from your UNILUX window.

Brand advantage 2: Freedom of design

Tastes are subjective. That's why you can choose from three models (IsoPlus, IsoStar, IsoStar-Alu), 27 different color schemes and wood patterns, 729 decorative combinations for uPVC windows (even over 90,000 for aluminium-clad uPVC windows), 34 handles, and several double-pane and triple-pane glass configurations. And let's not forget: the most diverse window shapes (they don't always have to be square) and, upon request, sash bars in three different lines. Variety works.

Brand advantage 3: Energy efficiency

UNILUX's solid construction style not only guarantees durability, but also helps save energy. Each of our uPVC windows has three gaskets and state-of-the-art "warm-edge" spacers between the glass panes, ensuring better thermal values, greater comfort near the window, and significantly reduced condensation build-up during colder months. Heating costs can be further reduced through highly efficient triple-pane glass with a thickness of 1 7/8"/48 mm to 2 1/16"/52 mm (PrimaTherm, SupraTherm, MegaTherm White).



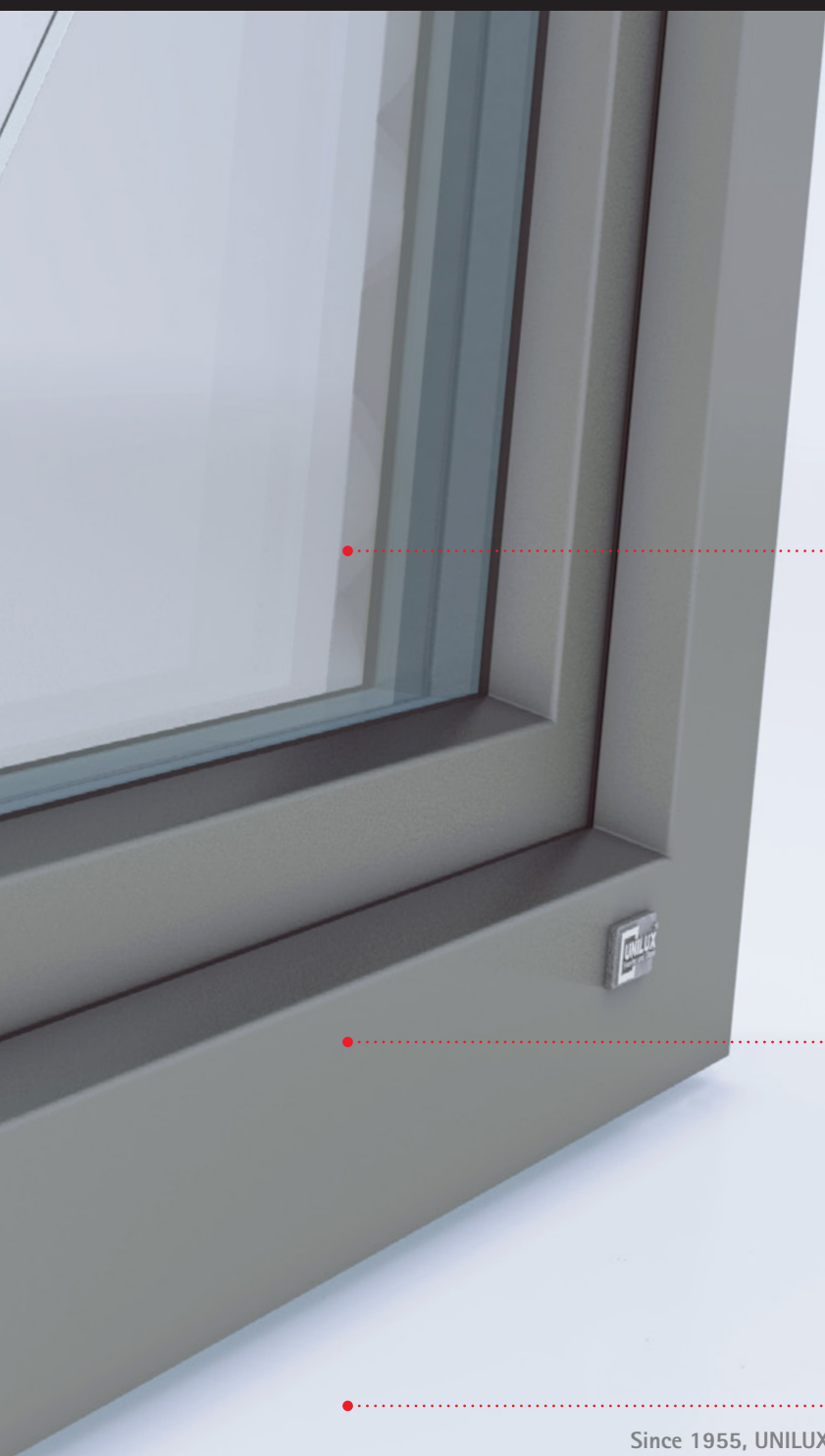

Brand advantage 4: Safety

Sometimes a window's job is not just to keep out wind and rain, but also uninvited guests. That's why all UNILUX locking parts are made from high-quality cast materials. Mushroom cams are also a standard feature of all our uPVC window fittings. For maximum protection, we offer the SAFE range (with the option of P2A safety glass, DIN-certified by the German National Authority on Fire Arms and Ammunition) and special BUS-compatible alarm systems which can be integrated into home security systems.

Brand advantage 5: Service

UNILUX only works with expertly qualified window specialist retailers, located across the country with their own showrooms. Your regional UNILUX retailer will offer you detailed advice and assist you with your plans. It will also ensure prompt, correct installation, and will be available at any time if you have any service-related needs.

Brand advantage 6: Brand quality

Since 1955, UNILUX's philosophy has been: Only products of uncompromising quality must leave the factory. This saw our company become a recognised quality leader over the decades. Anyone who pays heed to the UNILUX logo can be certain of always receiving a "Made in Germany"-branded product.

Live the way you are – naturally individual:
UNILUX uPVC windows



ADVANTAGES OF UPVC

Developed for generations

Windows have to withstand a lot of things. That's why we only use uPVC whose toughness, resilience and resistance to heat and cold can cope with hot summer days, autumn storms and cold winter nights. Internal steel reinforcement also ensures maximum durability.

The only understated area is the cost. You'll receive our uPVC handiwork at a price not worth compromising on.

**uPVC and aluminium-clad uPVC windows by UNILUX:
THE ORIGINALS.**

uPVC windows

IsoStar

The German energy saving ordinance, EnEV, requires that a window's heat transfer coefficient does not exceed 1.3 W/m²K – IsoStar will give you 0.73 W/m²K. And you'll have double the savings: at the time of purchase, and then every day and every night. Because this window keeps warmth where it belongs: in your house. IsoStar – the window of tomorrow at today's prices.



Clear lines

IsoStar looks impressive thanks to its simple, sophisticated lines and a construction depth of 88 millimetres. A timeless design which subtly accentuates the house's architecture.

Great insulation

One pane doesn't cost the earth. With the affordable PrimaTherm triple-glazing variety, you'll achieve optimum heat insulation. With a heat transfer coefficient of 0.6 W/m²K, PrimaTherm is even suitable for passive houses.

Thermal insulation

It's clear from the profile view: IsoStar has no less than 7 adjacent chambers and 3 gasket levels, achieving insulation values deemed virtually impossible for a uPVC window just a few years ago.

Steel reinforcements

Steel is integrated into the profile, and the hinges are screwed into the steel, achieving a particularly high degree of stability and durability, and guaranteeing long term enjoyment of your IsoStar window.

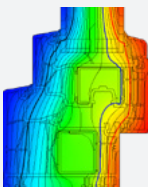

Uncompromising energy efficiency. Every UNILUX window meets today's high standards for energy efficiency. The solid frame absorbs the external temperature – reducing your need for heating. Ask your UNILUX partner how you can optimise your windows' energy efficiency.



UW VALUE
0.73
W/m²K

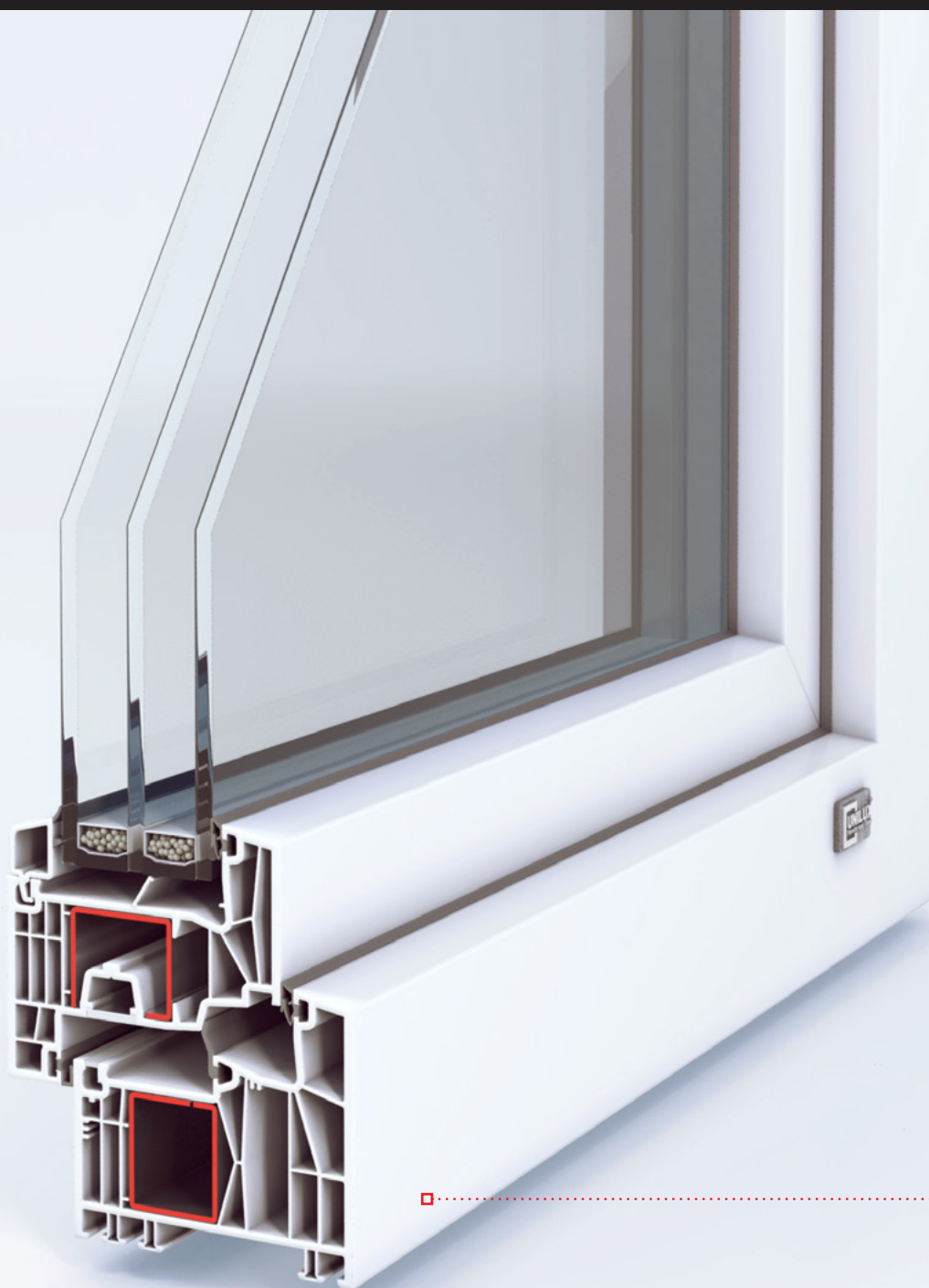

UNILUX IsoStar



Softline locking parts

Alternatively you can request for security striker plates. These are anchored in the steel of the frame profiles and increase the security against burglary.



Concealed and lacquered hinges

Upon request, the hinges can be integrated into the frame and thus be invisible when the window is closed. Alternatively you can request for color-coated hinges.



More comfort

The rolling, self-adjusting comfort mushroom cam automatically adapts to changed conditions, such as temperature fluctuations. Thus, you have an optimally adjusted and long-lasting locking system at all times.



Aluminium-clad uPVC windows

IsoStar-Alu

Built for generations to come. With IsoStar-Alu, you'll be setting a trench in thermal efficiency. Behind the weatherproof aluminium frame are energy-saving solutions enabling you to effectively reduce costs over the long-term. Sustainability which pays off for you.



Protective style

Outside: An elegant aluminium shell ensuring perfect structure and withstanding any storm. Inside: Steel-reinforced uPVC which guarantees maximum durability. Combined, they produce a window which combines aesthetics and durability..

Warming glass

For anyone wanting the best: With the affordable SupraTherm triple glazing, you'll achieve a heat transfer coefficient of just 0.5 W/m²K, making SupraTherm even suitable for passive houses.

Elegant insulation

Thermal insulation doesn't need to look cumbersome. With a construction depth of 88 millimetres, IsoStar-Alu achieves excellent insulation – even with triple glazing. That's how delicate energy efficiency can be.

Efficient insulation

Three seals minimise air permeability and increases wind resistance. Thermically separated spacers between the glass panes also improve insulation, and significantly reduce condensation build-up in colder months.

Glazing seal

Unilux uses EPDM, a synthetic rubber which impresses in the long term with its weather and moisture resistance.

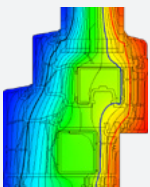

Uncompromising energy efficiency. Every UNILUX window meets today's high standards for energy efficiency. The solid frame absorbs the external temperature – reducing your need for heating. Ask your UNILUX partner how you can optimise your windows' energy efficiency.

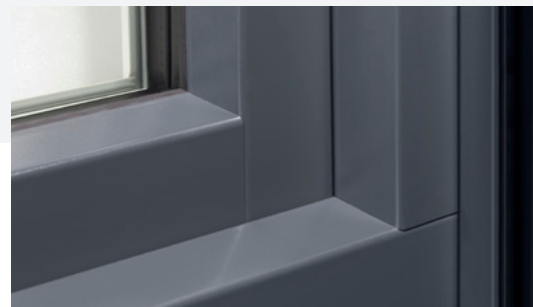

UW VALUE
0.75
W/m²K

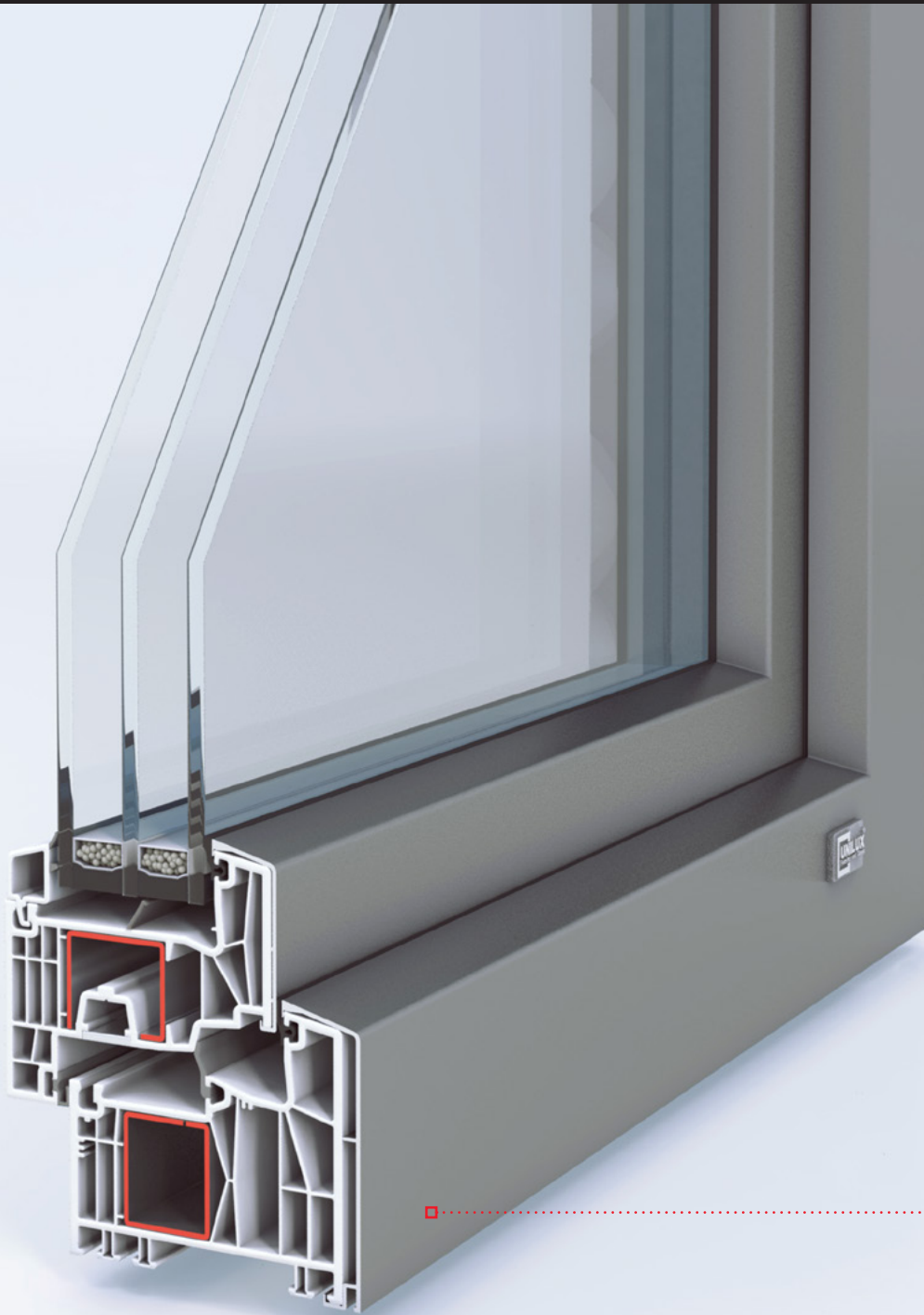

UNILUX IsoStar Alu





uPVC window

IsoPlus

No compromises! Our new series IsoPlus raises the bar – high insulation values, high stability, high security. Only the price is pleasantly low, lots of window for your money while still allowing you to make your design expectations come true.



Slim, but strong

76 millimeter installation depth is moderate. But it's enough to make a window that combines visual finesse with energy efficiency. That's provided by a clever chamber structure that ensures maximum noise and thermal insulation in just a little space.

Delicate but robust

Take a closer look to detect why the elegant IsoPlus is a model of solidity. For example, it has a fixed steel reinforcement. Used even in small windows, it provides long-lasting stability.

Modern or classical design

IsoPlus is available not only in numerous colors and wood patterns, but also in two different design options. That gives you the certainty that the window will fit harmoniously in modern or classical architectural applications.

Thermal and noise insulation

IsoPlus has multiple gaskets and technically highly developed insulating chambers. That effectively blocks wind, dust, rain and noise. That keeps the heat where it has to be: inside your house.

Triple-glazing in a slim profile

Despite a slimmer profile you could achieve Uw-values up to 0.78 W/m²K when opting for our SupraTherm glazing.

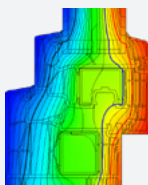

Thermal insulation without compromises. Every UNILUX window meets today's high standards for energy efficiency. The massive frame catches the outside temperature – reducing heating needs inside. Ask your UNILUX partner how you can optimize the energy balance of your windows.



Deceptively real

uPVC window with a wooden look? With UNILUX it's possible. Our wood patterns look alive and authentic, whether your favorite wood is pine or mahogany.

UW-WERT
0.78
 W/m²K

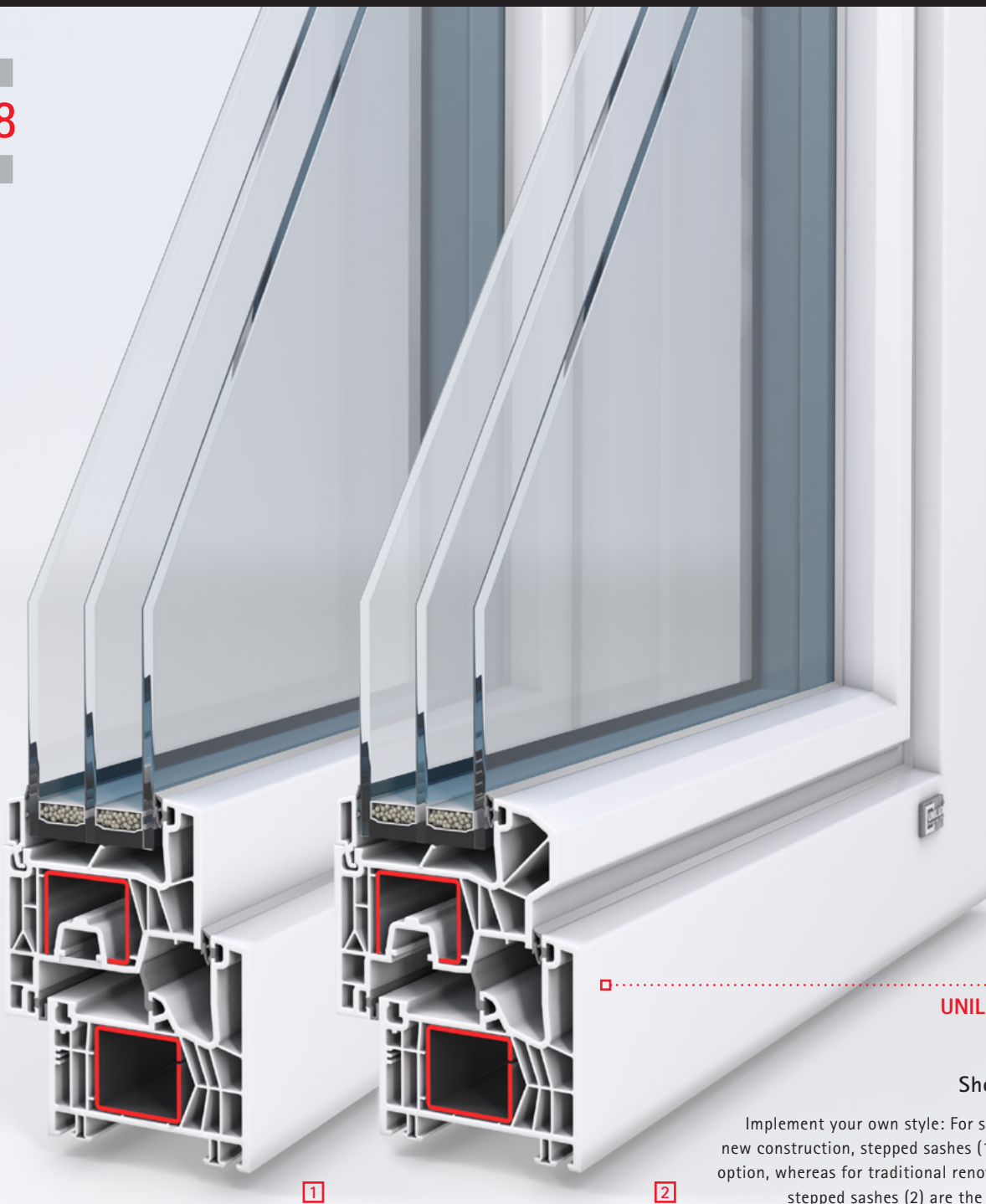

UNILUX IsoPlus

Show profile

Implement your own style: For straight-lined new construction, stepped sashes (1) are a good option, whereas for traditional renovations half-stepped sashes (2) are the ideal choice.



Fits visually as well

The "warm" edge spacer can be matched to either gray or black colored seals. That makes not only the energy management perfect, but also the visual appearance.



Softline locking parts

Alternatively you can request for security striker plates. These are anchored in the steel of the frame profiles and increase the security against burglary.



Concealed and lacquered hinges

Upon request, the hinges can be integrated into the frame and thus be invisible when the window is closed. Alternatively you can request for color-coated hinges.



Lift-and-slide system

IsoStar HS

Timeless aesthetics can still be affordable. With the IsoStar HS lift-and-slide system, you can have your dream of open, airy spaces. It also slides effortlessly. Available "barrier-free" (lower threshold, upon request) – for a unique unobstructed view.



Intelligent construction

To ensure absolute quality, we already thought outside the box while developing IsoStar HS. The key word: installation. Compensation for installation tolerances is possible through independent positioning of each panel. Just one example of the attention to detail.

Perfect design

A closer look will pay off since IsoStar HS is not only attractive technically, but also pleasing visually. For example, the Interlock has an integrated cover profile that creates a barrier to the elements while providing an appealing profile. It's details like this that show our sense of aesthetics – functionality that looks great.

Steel reinforcements

An installation depth of 207 mm. uPVC outside, metal inside. A substantial steel interlocking core contributes to giving the IsoStar HS the stability you expect from UNILUX.

Thermal protection

Want just one more layer? The triple glazing provides excellent thermal properties. Even in the cooler months, you'll still be able to enjoy the breathtaking view of the outdoors. The elements stay outside, while you remain warm and cozy inside.

Sealing system

Good for your wallet: energy efficiency is a standard feature. IsoStar HS has special thermal properties in the glazing plus a three-stage weatherproofing system composed of a significant central gasket protected by two additional gaskets. These elements are constructed of a long-lasting state of the art molded silicone.

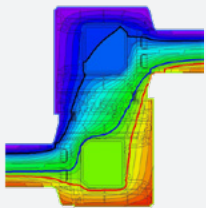

Thermal properties without compromises. Every UNILUX window meets today's high standards for energy efficiency. The chambered frame helps diminish the transfer of ambient temperatures – reducing heating and cooling needs. Ask your UNILUX partner how you can optimize the energy balance of your windows.



UW VALUE
0.70
W/m²K

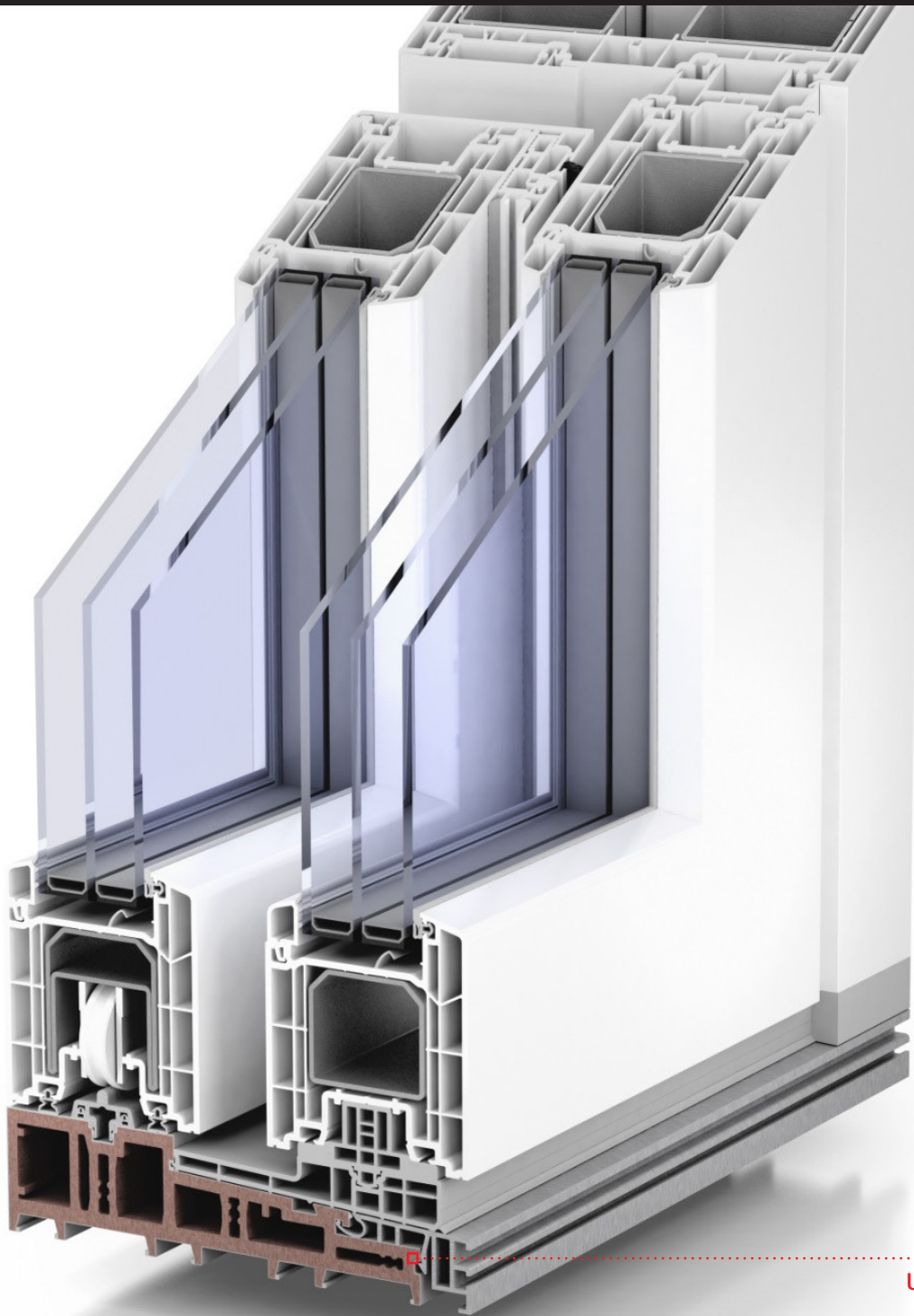

UNILUX IsoStar HS



Well-designed Interlock

Two is better than one. That's why the interlock has a double seal which is particularly impenetrable to the elements.



Flat threshold

The thermally broken aluminum and fiberglass-reinforced uPVC thresholds are color matched to the overall design.



Slim profile view

Thanks to a highly stable and refined design, the profile is only 100 millimeters thick. This gives IsoStar HS a special elegance, and less profile means more glass.



Lift-and-slide system

IsoStar-Alu HS

Sleek aluminum exterior, durable uPVC interior, and a dream of glass everywhere. The IsoStar-Alu HS lift-and-slide system gives your house a totally new feeling of open space. Thanks to the outstanding production quality, operating even the largest element is virtually effortless.



Perfection in detail

It's the little things that show the greatest quality, and some intelligent solutions are even hidden from sight. For example, IsoStar-Alu HS has invisible drainage downwards and the closed sash contour guarantees high profile stability.

Beauty at Its best

This is how elegant a profile can be: With a viewing width of only 100 millimeters, IsoStar-Alu HS is pleasantly slim. Also, the Interlock lock has an integrated cover for flawless aesthetics.

Steel reinforcements

The aluminum exterior, uPVC interior and substantial steel interlocking core contribute to giving the IsoStar-Alu HS the stability you expect from UNILUX.

Thermal protection

Three glazing layers are better than two. The additional glazing ensures unbelievable thermal values. The cold stays outside, and the heat inside. You can still enjoy the spectacular view even in the cooler parts of the year.

Sealing system

Good for your wallet: energy efficiency is a standard feature. IsoStar HS has special thermal properties in the glazing plus a three-stage weatherproofing system composed of a significant central gasket protected by two additional gaskets. These elements are constructed of a long-lasting state of the art molded silicone.

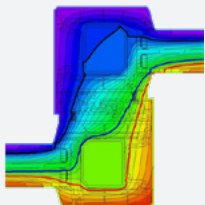

Thermal properties without compromises. Every UNILUX window meets today's high standards for energy efficiency. The chambered frame helps diminish the transfer of ambient temperatures – reducing heating and cooling needs. Ask your UNILUX partner how you can optimize the energy balance of your windows.



UW VALUE
0.70
W/m²K

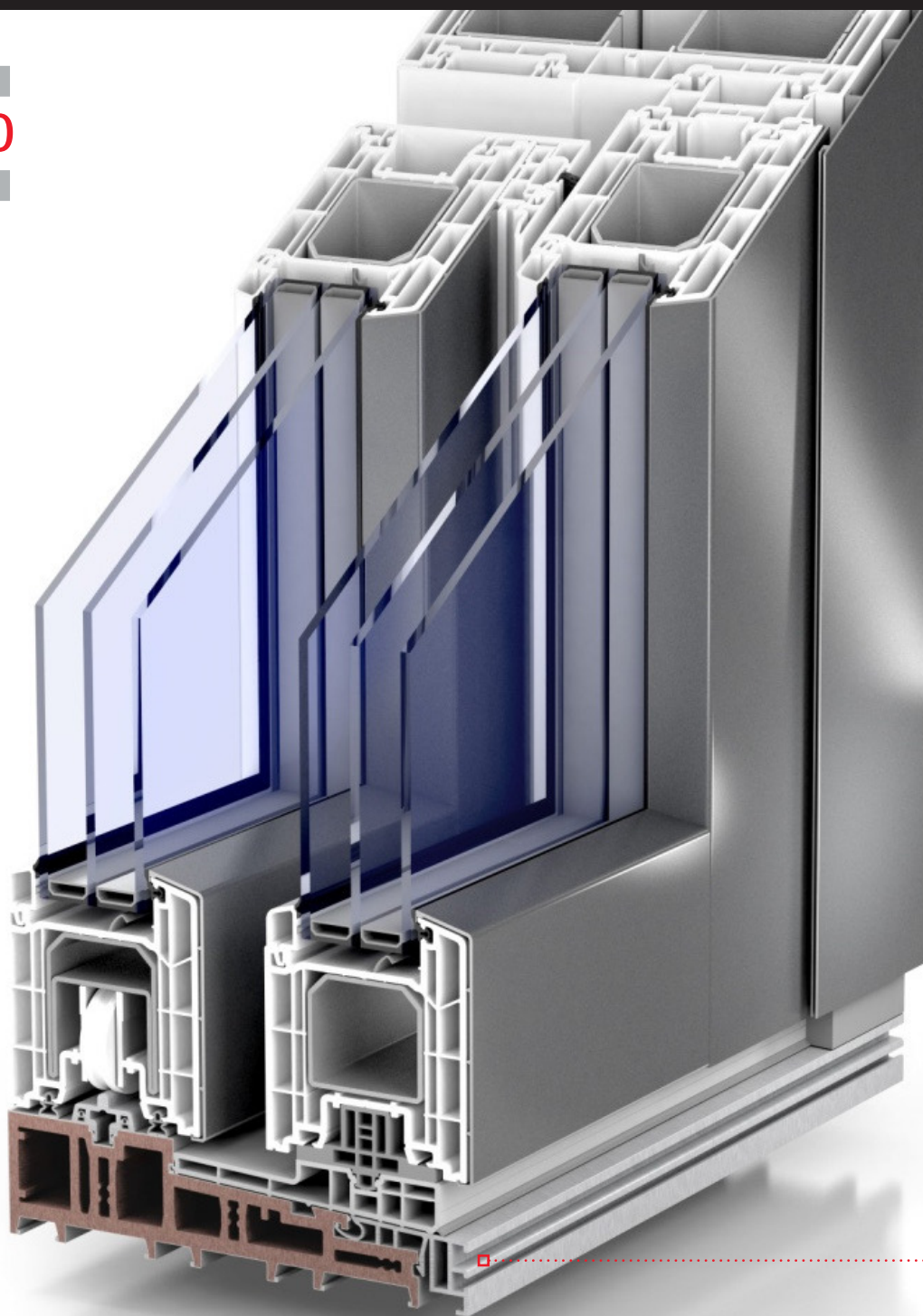

UNILUX IsoStar Alu HS



Smooth rails

The ultra-slim aluminum rails, together with the ball bearings rollers, allow a smooth glide that can't be beat.



Effective design

"Substantial" doesn't have to mean "BIG." With just twice the 88 mm panel depth, IsoStar-Alu HS has a subtle appearance while still standing tough against wind and weather.



Safe ventilation

Thanks to the built-in gap ventilation feature, the window can be left open at small width and still remain locked. This allows for safe conditions as well as a healthy exchange of air.

Lift-and-slide system

IsoPlus HS

Fulfill your dream of bright and light-filled living spaces: With the innovative lifting and sliding door system IsoPlus HS. Whether it's a green garden or an urban skyline – with IsoPlus HS, the generous glass surfaces allow you to integrate the outside world into your living environment. The modern, barrier-free system also convinces with maximum ease of use and high thermal insulation.

Perfect for new construction and renovation

Apart from new construction, the continuous 5-chamber construction with an installation depth of 179 mm, is also ideal for renovation. For even more comfort, the IsoPlus HS has a barrier-free threshold by default.

High incidence of light and solar heat recovery

The narrow face widths of the frame (65 mm), the sash (100 mm) and the center interlock (103 mm) allow high incidence of light as well as solar heat recovery. Glazing thicknesses of up to 50 mm can be installed in the IsoPlus HS.

Great variety of colors

In addition to the intrinsic values, you also be impressed by the elegant design and the large glass surfaces. With an installation height of up to 2.60 each light beam can be savored. The large variety of materials and colors, from classic white to high-quality foiled solutions, leave nothing to be desired.

Comfortable operation when opening and closing

The optional Soft-Close damper system slows down the heavy sash while moving it slowly into the locked position. This function reduces the risk of injury, prevents plaster breaks and protects the element.



For the sake of the environment

The sustainable, recyclable system solution made from environmentally friendly plastic profiles is made exclusively with lead-free calcium-zinc-based stabilizers.



UW VALUE
0.73
W/m²K

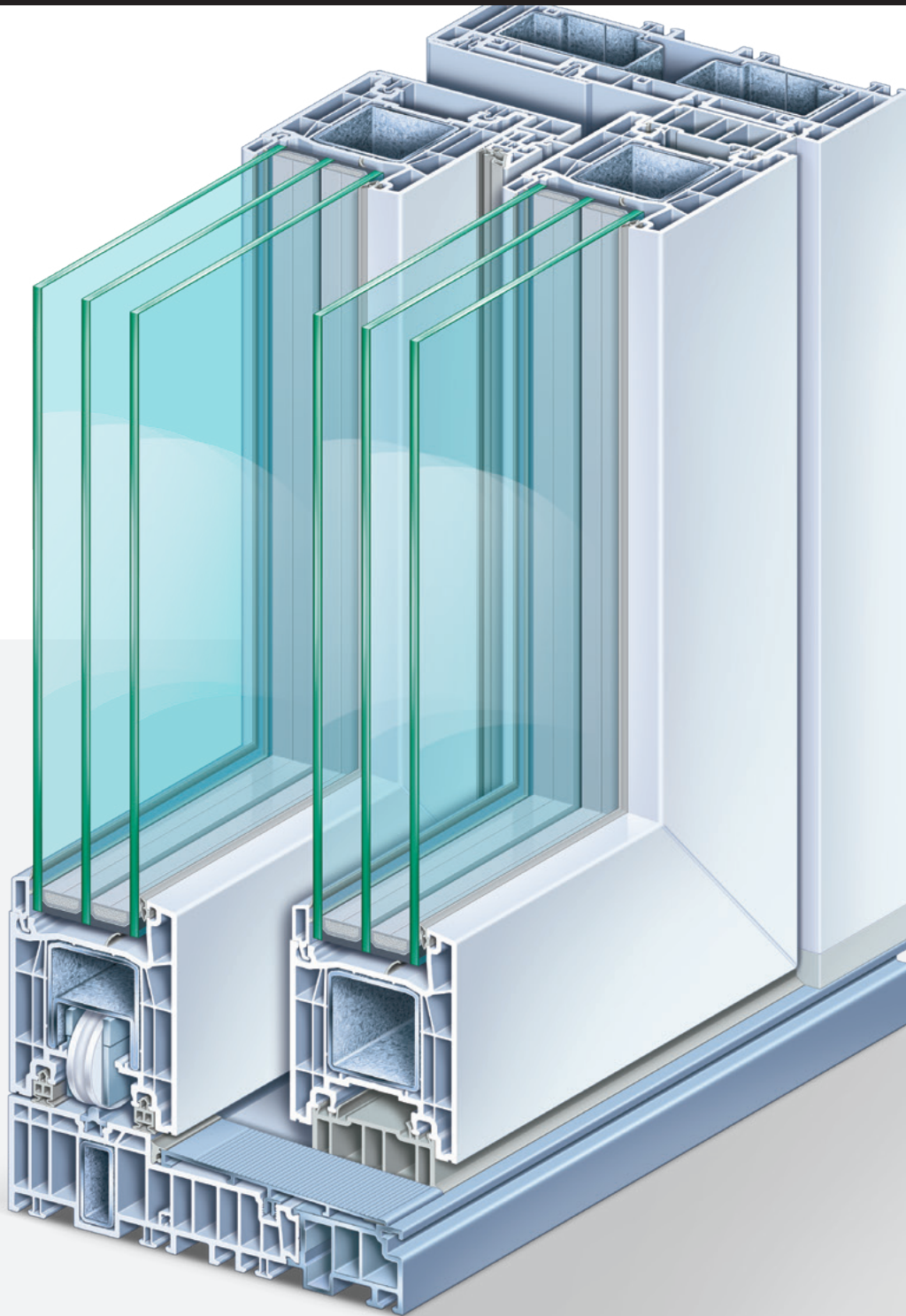

Lift-and-slide system

IsoPlus HS LUX

You get the lift-slide-system in the classic version or as an architectural variant IsoPlus HS LUX for even more incidence of light.

The intelligent construction reduces the sash profile, which enables extremely slim profile views and thus even larger glass surfaces as well as higher solar heat recovery.

UW VALUE

0.73

W/m²K

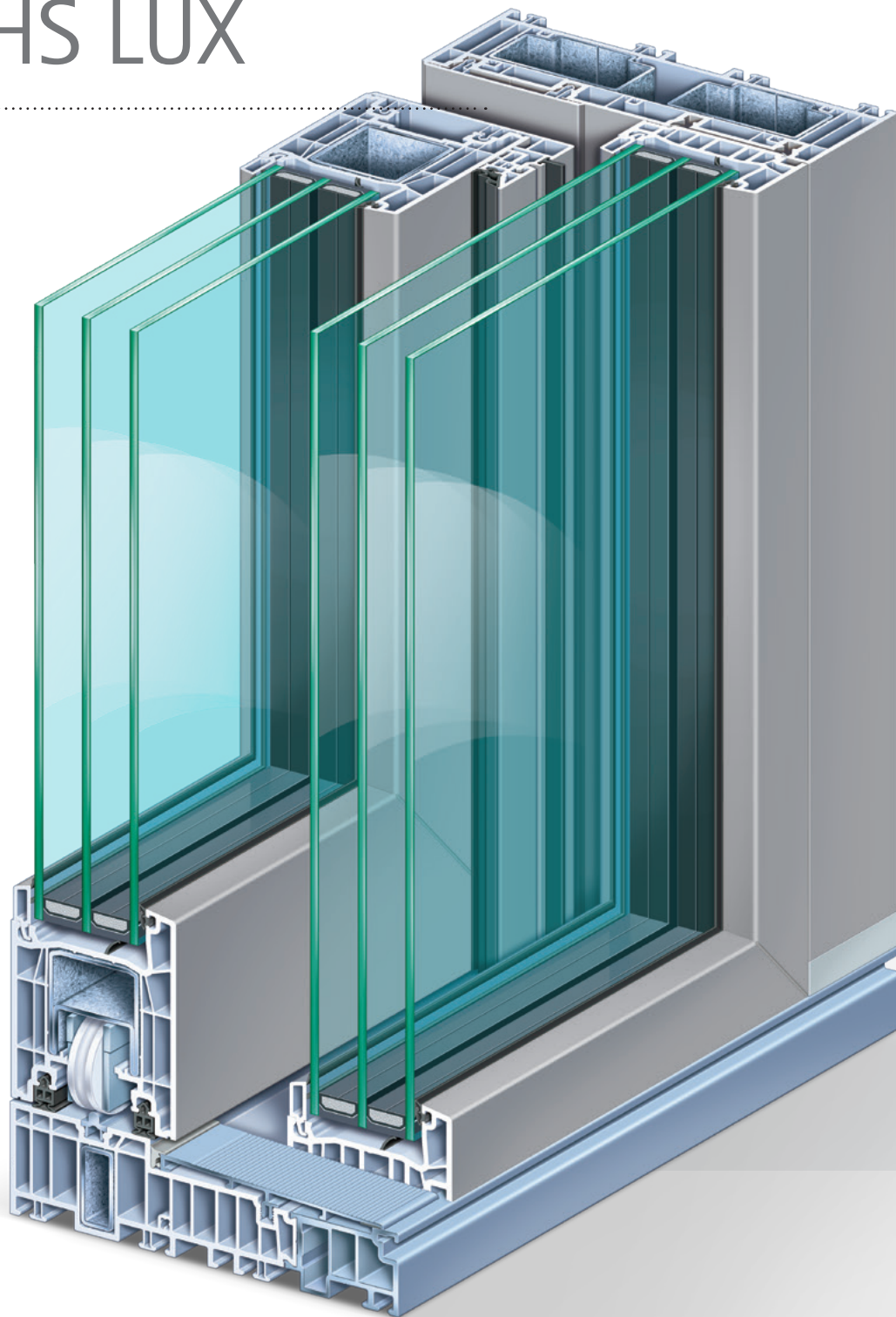

All opening variants at a glance

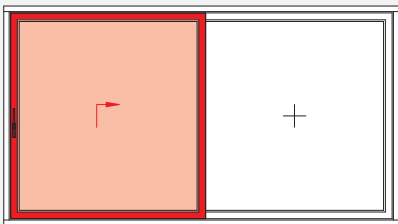

Scheme A

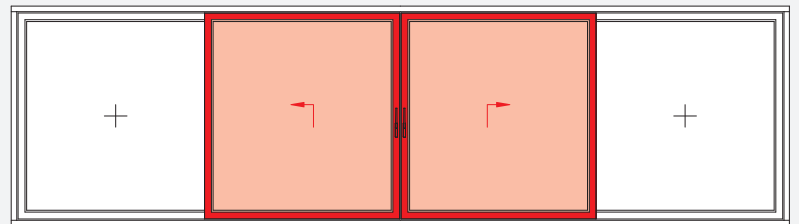

Scheme C

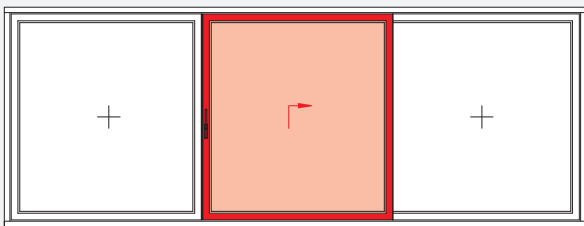

Scheme G1

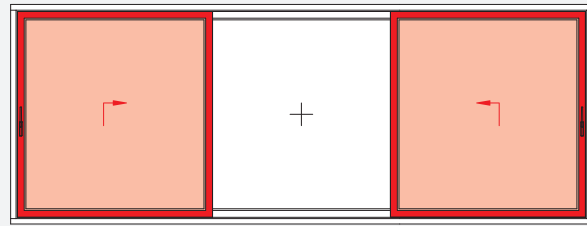

Scheme K (only possible with IsoPlus)

Better as a standard: the basic UNILUX advantages

As you know from buying cars, some models look cheap at first glance. But upon closer examination, you are incredulous at all the extras charged by the manufacturer.

That's not the case at UNILUX. Our basic features in themselves are so extensive, that there is often no need for accessories. Each of our standard uPVC and aluminium-clad uPVC windows has the following special features:

Fittings inserted with steel nuts

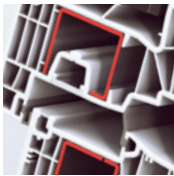

Stable sash: The fittings are securely screwed into the durable steel cores of our uPVC windows, safely channelling the window's tractive force into the stable sashes, strengthening mechanisms and effectively preventing wear and tear.

7-chamber system

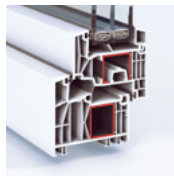

A 7-chamber system combined with a center seal enables our windows to achieve thermal insulation values which meet passive house standards.

Softline locking parts



Every standard UNILUX window has a mushroom cam in its fittings, which greatly prevents the window from being pried open. All locking parts are also made from high-quality materials, providing added security.

Aluminium powder coating



"The paintwork is chipped" is a phrase unfamiliar to UNILUX customers. Because our aluminium-clad uPVC windows are made using aluminium powder coating, which has been tried and tested in the automotive industry. The result is highly durable paintwork able to withstand even the harshest of elements.

Butt-joined aluminium cladding



The butt-joined aluminium ensures freedom of movement between the aluminium parts, evening out thermal differences. The UNILUX aluminium-clad uPVC windows thus also blend harmoniously into the entire UNILUX range.

Extra warmth: Triple glazing

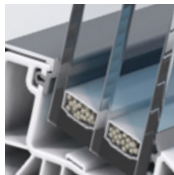

Three panes instead of two. The additional pane further improves thermal properties, thereby lowering energy costs. And as the pane is between 48 mm thick, it can also be effectively sound-proofed.



Extra perfect: the UNILUX optional advantages

Special circumstances require special solutions. That's why UNILUX offers exclusive added value when it comes to security, material protection and energy usage.

These additional benefits also give you the peace of mind of knowing that your window is second to none. Perfection, made by UNILUX.

Added security: SAFE



Standard UNILUX windows and doors are already equipped with mushroom-headed locking cams. If you like it even more secure, we offer increased protection through our various SAFE packages.

Choose between SAFE +, SAFE ++ and SAFE +++.

Plus: Aneloxal coating



It's not just acid rain which can corrode metal. Salty sea air can also have aggressive, negative impacts up to 60 miles/100 kilometers inland – including on stainless steel. Pre-anodising, – the

"aneloxal" process – effectively prevents corrosion. We are one of the very few manufacturers to use this form of coating at customers' requests, thereby ensuring UNILUX aluminum clad wood windows remain a symbol of durability, even in coastal areas.

Glass competence



You can not only design UNILUX windows visually, our glass can also be completely customized to your needs. It's your choice: Noise protection, security, sun protection or a higher degree of thermal

insulation – with UNILUX nothing is left to be desired.



Glass competence

UNILUX sets high standards in terms of glass, that is why every UNILUX window is fitted with 3-pane insulating glass as standard. But that alone is not enough for our engineers and developers. For all those who want more than just to design their windows, UNILUX offers various possibilities to upgrade their glass. However you decide, every UNILUX window is an example of groundbreaking glass competence.

Thermal insulation



These standard UNILUX glasses achieve insulation values that are by no means commonplace for windows. If that's not enough, you have the option to upgrade. You have the choice between

MegaTherm, which achieves sensational insulation values thanks to argon/krypton gas filling. Or PrimaTherm 0.6 White - Thanks to a new, invisible Low-e coating, you can use the energy from the sun's rays more effectively. More solar heat finds its way into the house. At the same time, this coating ensures that the cold stays outside.

Safety glass VSG, P2A + P4A



At UNILUX you get the glass that is adapted to your security needs. Starting with ball-proof safety, which is nowadays in demand not only in sports halls but also increasingly in private

homes, up to the P4A glass, which withstands rough attacks, such as stone throwing or hammer blows. The tested safety glass is joined with an invisible high-tear-resistant film between two panes and ensures adhesion and tension in case the glass shatters. The security class can be further enhanced by increasing the number of plastic films and glass panes.

Sun protection



Large window fronts bring brightness and atmosphere to our buildings. On the other hand, rooms can heat up quickly as the sun shines on the generous window panes. To counteract this, UNILUX

offers you sun protection glasses. The sun protection glass has two functions: In summer, it reduces solar radiation and thus reduces the heating of the building. In cool weather, the glass acts as a thermal protection and saves energy. The rays of the sun are reflected or absorbed by the solar protection glass without darkening the room.

Noise protection

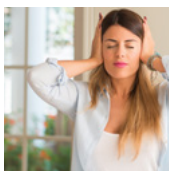

One of the important tasks of a home is to ensure sleep and recuperation. Regrettably, the noise pollution of our environment has greatly increased in the past. UNILUX offers the suitable glass for

different noise sources - whether for buildings on busy roads or near discos and airports. UNILUX offers you high-quality glazing with improved sound insulation up to class 5, i.e. up to 45 dB (test value).



Free choice of colors

How many different tastes are there? For UNILUX uPVC windows, there are exactly 729 different ones. Because there are so many ways of combining colors and wood patterns for your individual UNILUX uPVC window. (For aluminium-clad uPVC windows, there are actually over 90,000 combinations of aluminium cladding colors and uPVC decorations). Find out which colour looks best on the outside and which wood pattern or colour goes best inside.

27 colors and wood patterns are available for both interior and exterior design, and there are even more options for aluminium windows. Because the aluminium cladding comes in over 2,100 different colors and patterns (RAL, NCS, DB, anodized and white-pigment colors, as well as wood patterns).

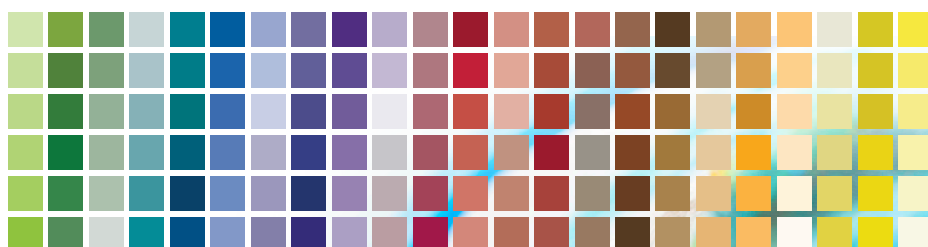

RAL-colors
wood patterns
DB & metallic colors
NCS-colors



Your world is colourful

Colors are an expression of personality and attitude towards life. Show off your taste and choose from a range of colors which leaves nothing to be desired.

Once good, always good

Whether it be uPVC or aluminium, UNILUX also sets standards when it comes to materials. We only use materials which display impressive durability and durability, RAL colors wood patterns DB & metallic colors NCS colors.

Deceptively authentic

UPVC windows can also have a wooden appearance. Our wood patterns look vibrant and authentic, regardless of whether you prefer pine or mahogany.



Endless variety in shapes

There are virtually no limits when choosing the shape of your uPVC or uPVC-aluminium window. Triangular or circular window? Segment or round arch? With or without sash bars? Your UNILUX retailer will show you what can be done.



A handle on design

Design you can grab: Every UNILUX handle is not only a solid piece of "Made in Germany" workmanship, but also a visual gem. A tool enabling you to express your taste and style.



Standard handle
silver colors

Standard handle
steel colors

Standard handle
bronze colors

Standard handle
white

Stainless steel handle
angular shape

Stainless steel handle
L-shape

Stainless steel handle
U-shape

Shades and screens

There are many different ways to protect yourself from intense sun and inquisitive eyes. Whether it be classic roller shutters or elegant blinds, UNILUX offers you a personalised shading and screening solution. We incidentally also have effective features to fend off insects.

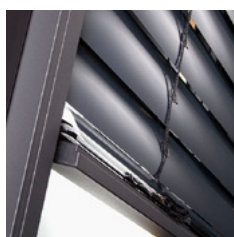

Venetian blinds

Blindingly bright or pitch dark? Venetian blinds give you many more nuances than that. They can control incoming light on a continuous basis. The strips, with their adjustable tilt, allow you to determine exactly how much sunlight you let into your rooms. And the Venetian blind also has an excellent visual appearance.



Venetian blinds

Top-mounted venetian shutter, made from polyurethane, with exterior inspection opening

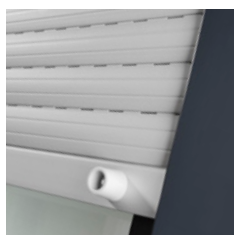

Roller shutter

When it comes to blocking out light, roller shutters have been the benchmark forever. No wonder they're preferred for use in bedrooms. And since the box appearance is the same as for our venetian blinds, you can combine UNILUX roller shutters and Venetian blinds together harmoniously.

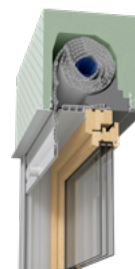

Roller shutter

Top-mounted roller shutter, made from polyurethane, with exterior inspection opening.

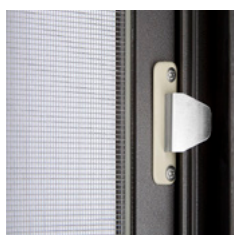

Insect protection

It's not just in bedrooms that insects are a bother. Biting flies and wasps can rob your enjoyment of the fresh air. So you can still air out without the worries, there are special clamping frames and rotating doors. You can easily mount these insect screens yourself. Comfort is so easy.

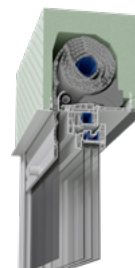

Roller shutter

Top-mounted roller shutter, made from polyurethane, with interior inspection opening.



Variety of sash bars

Sash bars are the icing on the cake when it comes to windows. Our products include three different lines, ranging from glass-dividing, to sealed-on, to embedded sash bars.



Lockability

Small children in particular should not be able to open every window. That's why we offer each model with a push button and as a lockable variant. Just to be sure.



Lots of different versions

UNILUX offers picture-book window shutters, premium roller shutters and insect screens which are either built into the roller shutter box as a roller blind, or act as a separate component.

The reliability of a big name

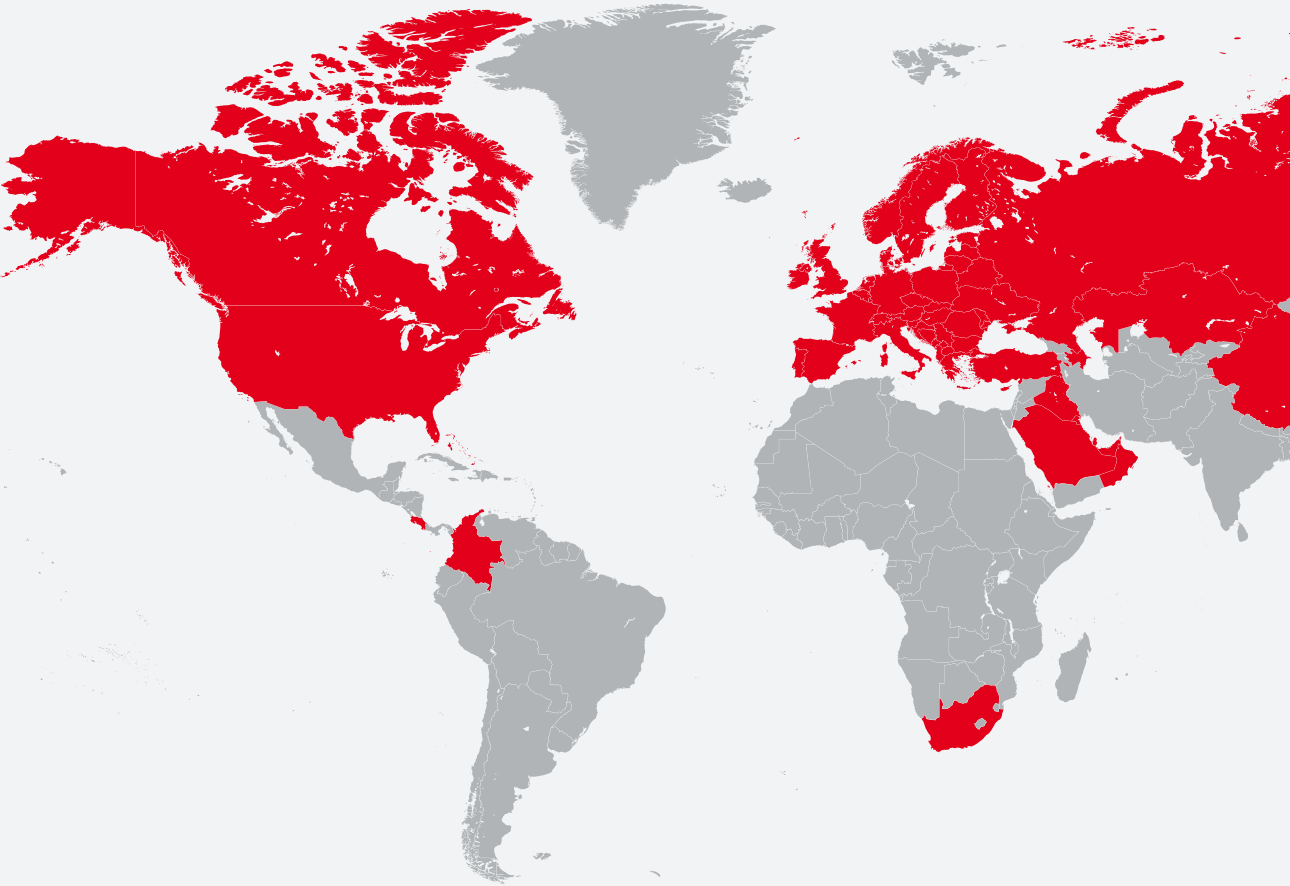

UNILUX ensures award-winning long-term progress

- by selecting the right partners and raw-material suppliers, and by being a member of leading institutions and associations:



UNILUX products meet international test and safety standards:





Company info

Publisher

UNILUX GmbH
54528 Salmtal / Germany
Telephone +49(0)6578/189-0
Facsimile +49(0)6578/1880

Email info@unilux.de
www.unilux.de

Notes

The content of this catalogue is not legally binding and may be subject to technical changes as part of further developments or errors in the text, images or descriptions. We only allow images and text material – including excerpts – to be used upon request, and with our express written consent.

The image material used is for illustrative purposes. Differences in colour are unfortunately unavoidable due to printing. The sample illustrations are not to scale.

© 2020, UNILUX GmbH. All rights reserved.



UNILUX headquarters, Salmtal

Photos: UNILUX, iStockphoto, Fotolia, Shutterstock

UNILUX GmbH
54528 Salmtal / Germany
Telephone +49(0)6578/189-0
Facsimile +49(0)6578/1880
E-Mail info@unilux.de

www.unilux.de



WHERE QUALITY IS AT HOME

Member of the **WERU** Group