

Live the way you are – naturally individual:
UNILUX wooden Meister windows



WOODEN MEISTER WINDOWS OVERVIEW



WHERE QUALITY IS AT HOME

Live the way you are – naturally individual:
UNILUX wooden Meister windows



WHERE QUALITY IS AT HOME

Contents

UNILUX: Where quality is at home	4-5
All good things come in sixes: Brand advantages of UNILUX	6-7
Advantages of wood	8-9
UNILUX wooden Meister windows	10-11
Wooden Meister window fittings	12-17
The reliability of a big name	18-19

Live the way you are – naturally individual:
UNILUX wooden Meister windows



WHERE QUALITY IS AT HOME

UNILUX

One brand. One promise.

Modern wooden windows only share a name with their „ancestors“. Good carpentry and appearance alone is no longer enough, because energy efficiency, safety and functionality standards have increased dramatically to meet today's customer needs.

That's why all UNILUX Meister windows are development projects that demonstrate intelligence and complex engineering.

To be able to provide access to these masterpieces to more than just a select few customers UNILUX mass-produces them. That means it's possible for us to offer these unique wood products at a price that makes top quality affordable.

Where quality is at home – UNILUX



All good things come in sixes:

The UNILUX brand advantages

Brand advantage 1: Durability

Since we were founded, UNILUX has always used the highest-quality materials. Down to the finest detail: UNILUX wood products rely on high-quality coatings with UV blockers. The high-quality production and strict quality control guarantee that you will enjoy your UNILUX product for years.

Brand advantage 2: Freedom of design

Some things are a matter of taste. You can choose from two design variants (slanted and rustic), four refined woods (pine, larch, oak, eukalyptus grandis), 189 colors and glazing tones, and several double-glazed and triple-glazed options. And let's not forget: a wide variety of window shapes (they don't have to be rectangular, after all) and sash bars upon request in four different lines. Variety right from the factory.

Brand advantage 3: Energy efficiency

UNILUX's solid construction style not only guarantees durability, but also helps save energy. In the standard version, each of our wood windows has a „warm edge“ which forms the thermal separation between the glass panes. That provides better insulation values, more comfort in the vicinity of the window, and significantly less condensation in cold months. Heating costs can be further reduced in conjunction with a highly efficient triple-glazing.





Brand advantage 4: Security

Sometimes a window's job is not just to keep out wind and rain, but also uninvited guests. That's why all UNILUX locking parts are made from high-quality materials. And each of our wood Meister windows has one mushroom cam per default. For those who want even more security, we offer maximum protection with our SAFE packages.

Brand advantage 5: Service

UNILUX works exclusively with our own qualified retailers. You can find them anywhere in Germany, right on site with their own local showrooms. Your regional UNILUX retailer will offer you detailed advice and assist you with your plans. They will also ensure prompt, correct installation and will be available at any time if you have any service-related needs.

Brand advantage 6: Brand quality

At UNILUX, there has always been one fast rule: Only products of uncompromising quality leave the factory. This made our company a recognized quality leader over the decades. Anyone who pays heed to the UNILUX logo can be certain of always receiving a „Made in Germany“-branded product.

Live the way you are – naturally individual:
UNILUX wooden Meister windows



WHERE QUALITY IS AT HOME



ADVANTAGES OF WOOD

Masterful design for pure comfort

Wood gives a feeling of wellbeing. It's a unique material that has lasted through all fashions and trends and has always inspired craftsmen and cabinetmakers to create beautiful works of art and craftsmanship. Us, too. With a wood product from UNILUX, you're always deciding on masterful design.

You can see it if you look closely. The details make the difference. For example, the striker plates on the wood Meister window, which we recess for flush mounting. The consistent elimination of unnecessary corners and edges gives the window a charming appearance. And for the long term, too: The varnish contain special pigments that protect the wood from UV radiation. That means you'll be able to enjoy the masterful workmanship for years.

Wood as wood – Meister windows from UNILUX.



Wooden Meister windows

The facets of style

No house is like any other. A renovated house from the early industrial era and the architecture of the 21st century can lie worlds apart. That's why UNILUX Meister windows have two different basic designs right from the start: Slanted and rustic. Your personal style can already be seen in the window contour itself.



Slanted

Clear edges: This design concept was developed specifically for modern architecture, attractive for its cool, no-frills lines. Futuristic and stylish.

Rustic

Eternal values: With its powerful stepped visuals, this design line evokes the handbuilt windows of yesteryear. A natural for traditional construction and original facades in older houses.

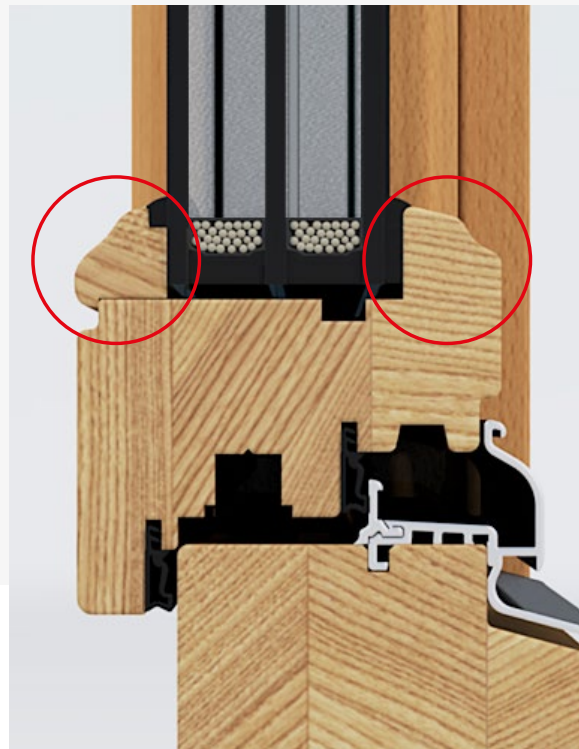
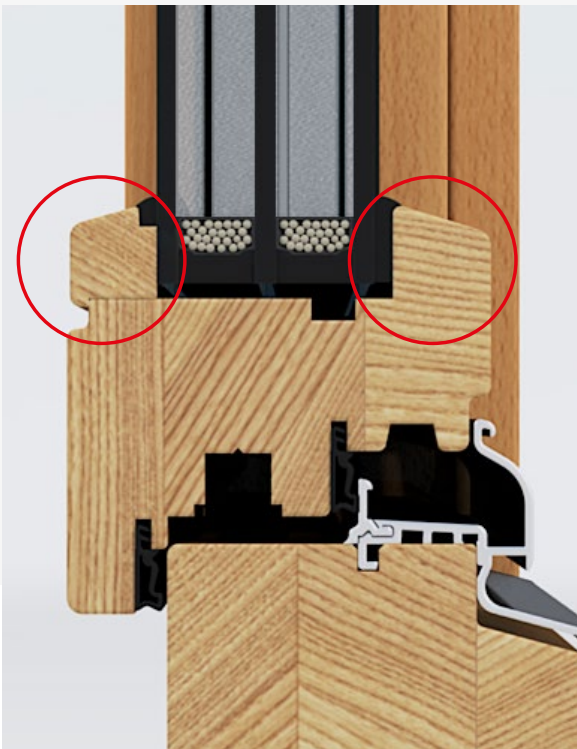

UW-VALUE
0.9
 W/m²K



UNILUX Meister window slanted



Recessed striker plates

Not just visually attractive, but also – thanks to the flat surface against the screw-mounted locking parts – from a security perspective, too. Not to mention easier to clean!



Wood, pure and simple

Solid and of the highest quality. UNILUX quality can be recognized by the fact that the furniture-grade finished wood is still attractive after many years.



Mushroom pins for added security

The mushroom-shaped locking device makes break-in attempts harder. Upgradable to 4 corner locking points (SAFE package) and EN-verified Class 2 burglar resistance upon request.

Quality as a standard: the basic UNILUX advantages

You know it from buying cars: Some models seem cost-effective at first glance. But upon closer examination, you are incredulous at all the extras charged by the manufacturer.

Not with UNILUX. Our basic features in themselves are so extensive, that there is often no need for accessories. Every one of our wood Meister windows has the following standard equipment features:

Coating system



3 plus 2 equals long life for wood. UNILUX coats wood in three stages, then treats its surface in two stages. The electrostatic coating and the sanding of the surface before coating and after the prime coat ensure excellent treatment and surface quality. And – thanks to laser testing – nearly knot-free.

Thermal insulation without compromises

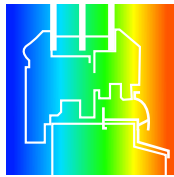

Every UNILUX window meets today's high standards for energy efficiency. The stable frame catches the outside temperature – reducing heating needs.

Superior-quality wood

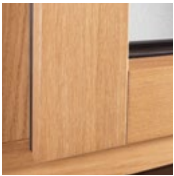

Not all woods are the same. To guarantee a consistently high quality of materials, we use our own experienced wood buyers, even in the farthest corners of the Earth. The same strict standards are

applied during treatment – to ensure the wood has a long and healthy life.

Extra warmth: Triple glazing



Three panes instead of two. The additional layer of glass provides even better thermal insulation and therefore even lower energy costs. And since the pane itself has a thickness of 40 mm, it can also be

efficiently equipped with noise protection.

Multi-layered wood bonding



Stability guaranteed. Multi-layered bonding equalizes stresses between the solid-wood layers and wood surface, thereby ensuring absolute torsional rigidity.

Recessed striker plates



Impressive not only aesthetically, but also from a security perspective – due to being recessed compared to screwed-on locking parts. Not to mention easier to clean!



Extra perfect: the UNILUX optional advantages

Special circumstances require special solutions. That's why when it comes to security and thermal efficiency, UNILUX offers exclusive added value.

These additional benefits give you the certainty that your wood Meister window is top in its class. Perfection made by UNILUX.

Added security: SAFE



In standard version, our windows and glazed doors already have secure mushroom-pin locks. For those who want even more security, we offer maximum protection

with our SAFE packages. Choose between SAFE +, SAFE ++ and SAFE +++.

Glass competence

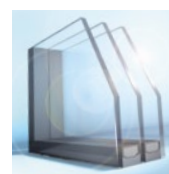

You can not only design UNILUX windows visually, our glass can also be completely customized to your needs. It's your choice: Noise protection, security, sun protection or a higher

degree of thermal insulation - with UNILUX nothing is left to be desired.



Glass competence

UNILUX sets high standards in terms of glass, that is why every UNILUX window is fitted with 3-pane insulating glass as standard. But that alone is not enough for our engineers and developers. For all those who want more than just to design their windows, UNILUX offers various possibilities to upgrade their glass. However you decide, every UNILUX window is an example of groundbreaking glass competence.

Thermal insulation



These standard UNILUX glasses achieve insulation values that are by no means commonplace for windows. If that's not enough, you have the option to upgrade. You have the choice between

MegaTherm, which achieves sensational insulation values thanks to argon/krypton gas filling. Or PrimaTherm 0.6 White - Thanks to a new, invisible Low-e coating, you can use the energy from the sun's rays more effectively. More solar heat finds its way into the house. At the same time, this coating ensures that the cold stays outside.

Safety glass VSG, P2A + P4A



At UNILUX you get the glass that is adapted to your security needs. Starting with ball-proof safety, which is nowadays in demand not only in sports halls but also increasingly in private homes, up to

the P4A glass, which withstands rough attacks, such as stone throwing or hammer blows. The tested safety glass is joined with an invisible high-tear-resistant film between two panes and ensures adhesion and tension in case the glass shatters. The security class can be further enhanced by increasing the number of plastic films and glass panes.

Sun protection



Large window fronts bring brightness and atmosphere to our buildings. On the other hand, rooms can heat up quickly as the sun shines on the generous window panes. To counteract this, UNILUX

offers you sun protection glasses. The sun protection glass has two functions: In summer, it reduces solar radiation and thus reduces the heating of the building. In cool weather, the glass acts as a thermal protection and saves energy. The rays of the sun are reflected or absorbed by the solar protection glass without darkening the room.

Noise protection

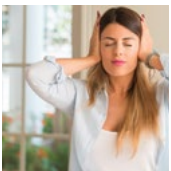

One of the important tasks of a home is to ensure sleep and recuperation. Regrettably, the noise pollution of our environment has greatly increased in the past. UNILUX offers the suitable glass for different

noise sources - whether for buildings on busy roads or near discos and airports. UNILUX offers you high-quality glazing with improved sound insulation up to class 5, i.e. up to 45 dB (test value).



The wide choice of colors

How many different tastes are there? When it comes to woods and colors, about 560. That's the number of combination options you have for your custom UNILUX wood Meister windows. Find out which wood harmonizes best with which color or wood glaze.

You have four highly robust woods to choose from (pine, larch, oak, eukalyptus grandis), as well as 180 covering paint colors and 9 exclusive glazing tones for outstanding UV protection.

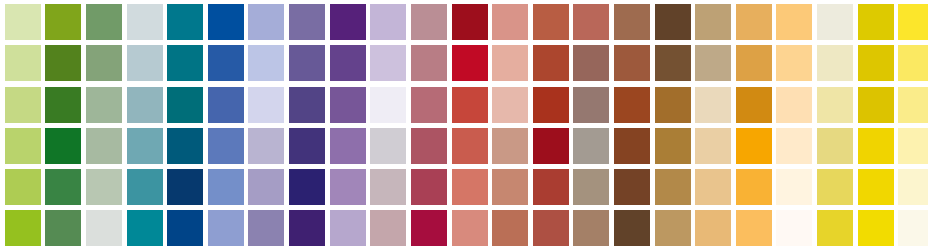

RAL colors
Wood patterns

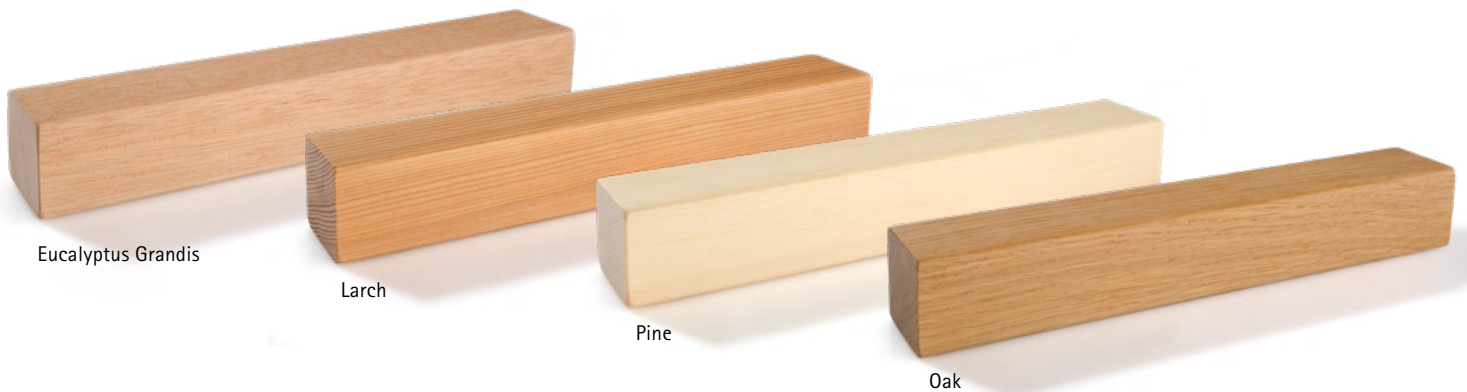

Eucalyptus Grandis

Larch

Pine

Oak



You love wood

Wood is a living material. It's nice to be able to integrate it into one's living space. UNILUX wood Meister windows bring that liveliness into your living room.



Your world is colorful

Colors are an expression of personality and attitude towards life. Show off your taste by choosing from a range of colors that leaves nothing to be desired.

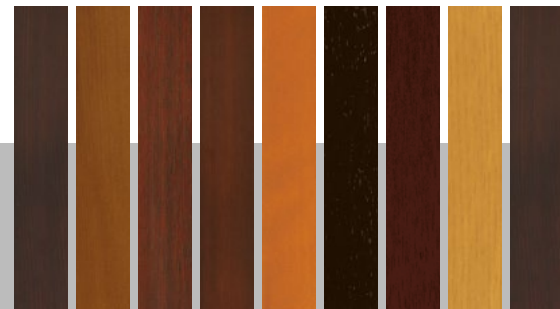

It's your choice

When it comes to wood colors, too, UNILUX always gives you the choice. Select from a wide variety of wood species, and make the most of the options for designing the wood's color scheme.



Endless variety of shapes

When choosing the shape of your wood Meister window, there are practically no limits. Triangular or round window? Sectional or semicircular arch? With or without muntins? Your specialized UNILUX trade partner will show you what's possible.



A handle on design

Design you can grab: Every UNILUX handle is not only a solid piece of workmanship „Made in Germany“, but also a visual gem. It is a tool that allows you to express your taste and style.



Standard handle
silver colors

Standard handle
steel colors

Standard handle
bronze colors

Standard handle
white

Stainless steel handle
angular shape

Stainless steel handle
L-shape

Stainless steel handle
U-shape

Shades and screens

There are different options for protection from intensive sunlight and curious eyes. Whether classical roller shutters or elegant venetian blinds, UNILUX offers you your individual shade and screen solution. By the way, we have a few good recipes against insects, too.

Venetian blinds



Blindingly bright or pitch dark? Venetian blinds give you many more nuances than that. They can control incoming light on a continuous basis. The strips, with their adjustable tilt, allow you to determine exactly how much sunlight you let into your rooms. The venetian blind also has an excellent visual appearance.

Roller shutter

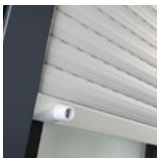

When it comes to blocking out light, roller shutters have been the benchmark forever. No wonder they're preferred for use in bedrooms. And since the box appearance is the same as for our Venetian blinds, you can combine UNILUX roller shutters or our venetian blinds together harmoniously.

Insect protection

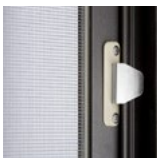

It's not just in bedrooms that insects are a bother. Biting flies and wasps can rob your enjoyment of the fresh air. So you can still air out without the worries, there are special clamping frames and rotating doors. You can easily mount these insect screens yourself. Comfort is so easy.

Every house facade is different. That's why UNILUX lets you select from different box variants when it comes to privacy protection.

For new construction we recommend plaster base variants, because roller shutters or venetian blinds are then integrated into the external stucco. There is no break in the masonry in this case – no thermal bridge, meaning less energy consumption.

Good to know: For boxes with exterior modification, you can put up wallpaper inside with no worries – the visually bothersome modification cover disappears.



Round roller shutter
Round visuals, specifically eye-catching

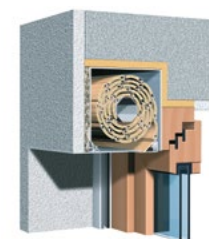

Plaster support variants
Behind the stucco – nearly invisible.



Variety of bars and dividers

Divided lights are the icing on the cake when it comes to a window's appearance. Our range covers four different lines, from true divided and simulated divided lites to the astragal and georgian bar designs.

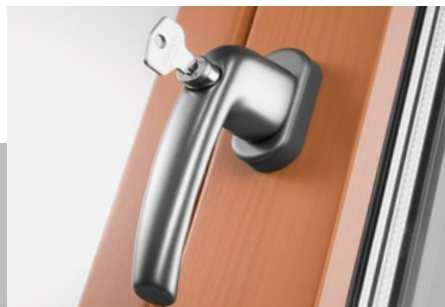

Lockability

Not every window needs to be opened, especially when there are small children around. That's why most of our handles come with a lock button, and are also available as lockable variants. Just in case.



Sunshades and more

At UNILUX, we have storybook shutters, first-class roller shutters and insect screens that are either built into the roller shutter box or act as a separate component.

The reliability of a big name

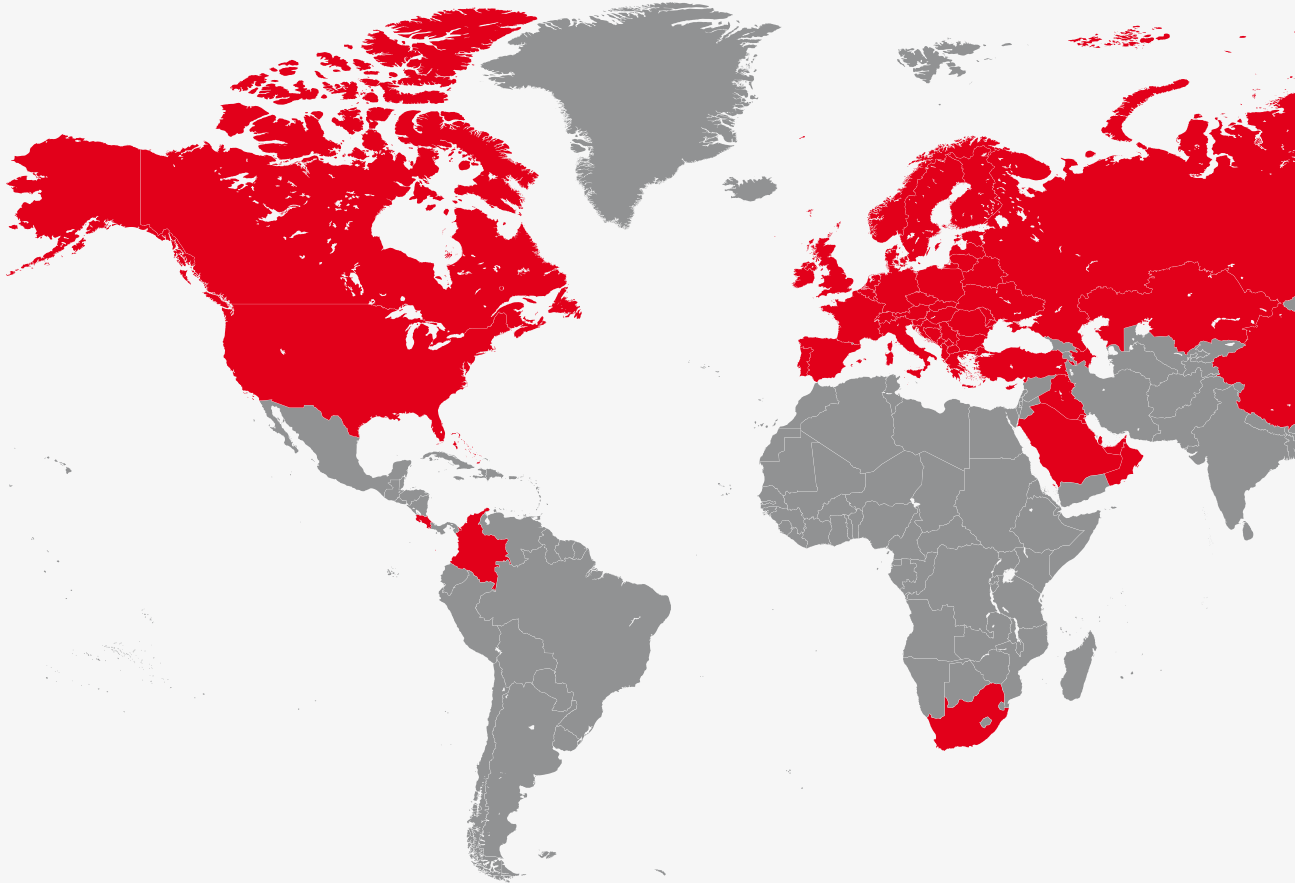

UNILUX ensures award-winning long-term progress

- by selecting the right partners and raw-material suppliers, and by being a member of leading institutions and associations:



UNILUX products meet international test and safety standards:





Company info

Publisher

UNILUX GmbH
54528 Salmtal / Germany
Telephone +49(0)6578/189-0
Facsimile +49(0)6578/1880

Email info@unilux.de
www.unilux.de

Notes

The content of this catalogue is not legally binding and may be subject to technical changes as part of further developments or errors in the text, images or descriptions. We only allow images and text material – including excerpts – to be used upon request, and with our express written consent.

The image material used is for illustrative purposes. Differences in colour are unfortunately unavoidable due to printing. The sample illustrations are not to scale.

© 2020, UNILUX GmbH. All rights reserved.



UNILUX headquarters, Salmtal

UNILUX GmbH
54528 Salmtal / Germany
Telephone +49 (0) 65 78 / 189-0
Facsimile +49 (0) 65 78 / 18 80
E-Mail info@unilux.de

www.unilux.de



WHERE QUALITY IS AT HOME

Member of the **WERU** Group